



# Main Catalog

## Dental 2023



Competence in Instruments  
MADE IN GERMANY

02	<i>SCALPELS AND PERIOTOMES</i>	P.	5-7
03	<i>SCISSORS</i>	P.	8-14
04	<i>TC SCISSORS</i>	P.	15-16
05	<i>MICRO SCISSORS</i>	P.	17-18
08	<i>DISSECTING AND TISSUE FORCEPS</i>	P.	19-23
09	<i>MICRO AND ATRAUMATIC FORCEPS</i>	P.	24-27
10	<i>COLLEGE FORCEPS AND MEASURING INSTRUMENTS</i>	P.	28-33
13	<i>HEMOSTATIC FORCEPS</i>	P.	34-37
17	<i>AUXILLARY CLAMPS AND FORCEPS</i>	P.	38-41
19	<i>NEEDLE HOLDER</i>	P.	42-43
20	<i>TC NEEDLE HOLDER</i>	P.	44-53
24	<i>RETRACTORS</i>	P.	54-66
27	<i>ELEVATORS AND RASPATORIES</i>	P.	67-73

31	<i>BONE RONGEURS</i>	P.	74-76
42	<i>MEASURING DEVICES</i>	P.	77-78
46	<i>SINUS CURETTES</i>	P.	79-82
48	<i>MOUTH WEDGER, GAGS, DEPRESSORS</i>	P.	83-88
67	<i>BONE PREP INSTRUMENTS AND TOOLS</i>	P.	89-102
68	<i>HARD AND SOFT TISSUE AUGMENTATION SCREWS AND PINS</i>	P.	103-111
73	<i>ORGANIZATION AND STORAGE</i>	P.	112-115
79	<i>CLEANING AND CARE</i>	P.	116
80	<i>EXTRACTING FORCEPS ENGLISH PATTERN</i>	P.	117-132
81	<i>EXTRACTING FORCEPS WITH ANATOMICALLY SHAPED HANDLE</i>	P.	133-139
83	<i>ROOT ELEVATORS</i>	P.	140-151
84	<i>BASIC INSTRUMENTS, MOUTH MIRRORS AND SYRINGES</i>	P.	152-159
85	<i>PERIODONTICS</i>	P.	160-172

<b>86</b> <i>HAND INSTRUMENTS</i>	P. 173-182
<b>87</b> <i>PROSTHETICS &amp; ROOF RESECTION</i>	P. 183-188
<b>88</b> <i>IMPRESSION TRAYS</i>	P. 189-191
<b>89</b> <i>PROSTHETICS</i>	P. 192-197
<b>90</b> <i>STORAGE, ORGANISATION AND STERILIZATION</i>	P. 198-206
<b>91</b> <i>INSTRUMENT SETS</i>	P. 207-223

# 02

# SCALPELS AND PERIOTOMES



# 02

## Standard Scalpels and Blades

Blades, sterile, 100pcs.



02-040-011  
Size 11



02-040-012  
Size 12



02-040-015  
Size 15



02-040-124  
Size 12D



02-040-153  
Size 15C



1/1



1/1



1/1



02-030-030

Scalpel Handle,  
No. 3  
125mm

02-030-070

Scalpel Handle,  
No. 7

02-030-150 G

Scalpel Handle,  
15 cm, round  
shaped, smooth

02-046-022

BLADE BUTLER, for  
removing scalpel blades  
from handle

## Standard Scalpels and Blades/Periotomes

# 02

Micro Blades, sterile, 25pcs.



**02-044-063**  
Size 63



**02-044-067**  
Size 67



**02-044-069**  
Size 69



1/1

**02-038-140**

Micro-Scalpel Handle, 14 cm,  
anatomical shape



1/1

**02-795-000POT3**

Periotome, size 1, straight,  
complete, peek handle



1/1

**02-796-000POT3**

Periotome, size 1, straight,  
complete, peek handle

# 03

# SCISSORS





REYNOLDS



03-155-145

14.5cm, delicate, curved

METZENBAUM



03-071-145

14.5cm, curved

JAMESON



03-185-155

15.5cm, delicate, curved



03-081-145

14.5cm, delicate, curved

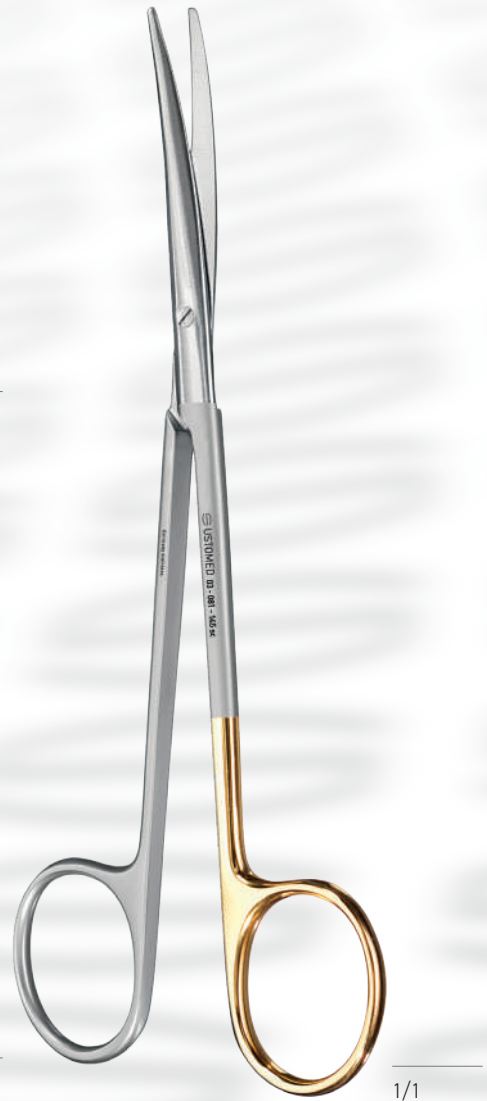

03-081-145 SC

14.5cm, delicate, curved, Super-Cut

KILNER



03-449-120

12cm, delicate, curved

# 03

## Suture & Gum Scissors

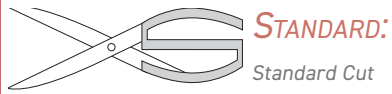

**STANDARD:**  
Standard Cut

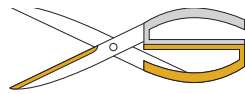

**SUPERCUT (SC):**

Special Cut with tothing in one scissor blade in order to prevent sliding of gum and suture material



You can find the TC Version of this Scissor in Chapter 04!



1/1



1/1



1/1

11.5cm, straight

**03-320-115**

Standard

**03-320-115 SC**

Super-Cut

**03-316-115**

Standard, large ring

11.5cm, curved

**03-321-115**

Standard

**03-321-115 SC**

Super-Cut

**03-317-115**

Standard, large ring

13cm, X-tra large ring

**03-327-130**

curved

**03-327-130 SC**

curved, Super-Cut

**03-326-130**

straight

JOSEPH



14cm, straight

**03-440-140**

Standard

**03-440-140 SC**

Super-Cut



14cm, curved

**03-441-140**

Standard

**03-441-140 SC**

Super-Cut



1/1

curved, Standard

**03-631-160**

16cm

**03-631-180**

18cm

KELLY



1/1

straight, Standard

**03-630-160**

16cm

**03-630-180**

18cm



1/2

curved, Super-Cut

**03-631-160 SC**

16cm

**03-631-180 SC**

18cm

# 03

## Suture & Gum Scissors

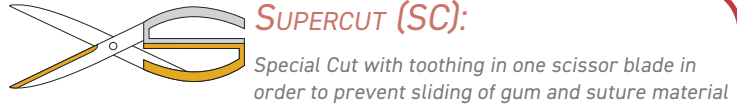
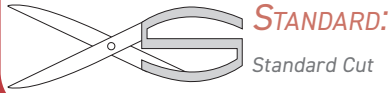

### FOX



13cm, curved  
**03-417-130**  
 serrated  
**03-421-130**  
 plain



13cm, straight  
**03-412-130**  
 serrated  
**03-420-130**  
 plain



**03-417-130 SC**  
 13cm, curved, Super-Cut

### LA GRANGE



10.5cm  
**03-401-105**  
 Standard  
**03-401-105 SC**  
 Super-Cut

# LOCKLIN

Gum Scissors

03-365-160

16cm, serrated



# SPENCER



1/1

Ligature Scissors

03-720-130

13cm



1/1

03-325-115

11.5cm, angled



1/1

03-351-115

11.5cm, very fine tips

# 03

## Special Scissors

### SURGICAL SCISSORS

### BEEBEE

### LISTER



### UNIVERSAL



sharp/blunt tips

03-022-145  
straight, 14.5cm

03-022-175  
straight, 17.5cm

03-745-105

Wire-Cutting Scissors,  
10.5cm, curved, sharp

03-805-180

Universal Bandage Scissors,  
18cm

04

# TC SCISSORS



# 04

## TC Suture & Gum Scissors



**TUNGSTEN CARBIDE (TC):**  
Special Hard-Metal Inlays increasing life time and sharpness, of the Instrument

### FOX

### JOSEPH



 1/1	 1/1	 1/1
<b>04-417-130</b> 13cm, curved, serrated	<b>04-441-140</b> 14cm, curved	<b>04-521-115</b> 11.5cm, curved
	 1/1 <b>04-440-140</b> straight	 1/1 <b>04-520-115</b> 11.5cm, straight



# 05

## MICRO SCISSORS



# 05

## Micro Scissors

### I'MOTION



1/1

**05-803-180**

18cm, curved



1/1

curved, round

**05-809-145**

14.5cm

**05-809-180**

18cm



1/2

**05-621-145**

14.5cm, very fine tips,  
flat handle



1/2

**05-801-145**

14.5cm, x-fine tips, round

# 08

# DISSECTING AND TISSUE FORCEPS

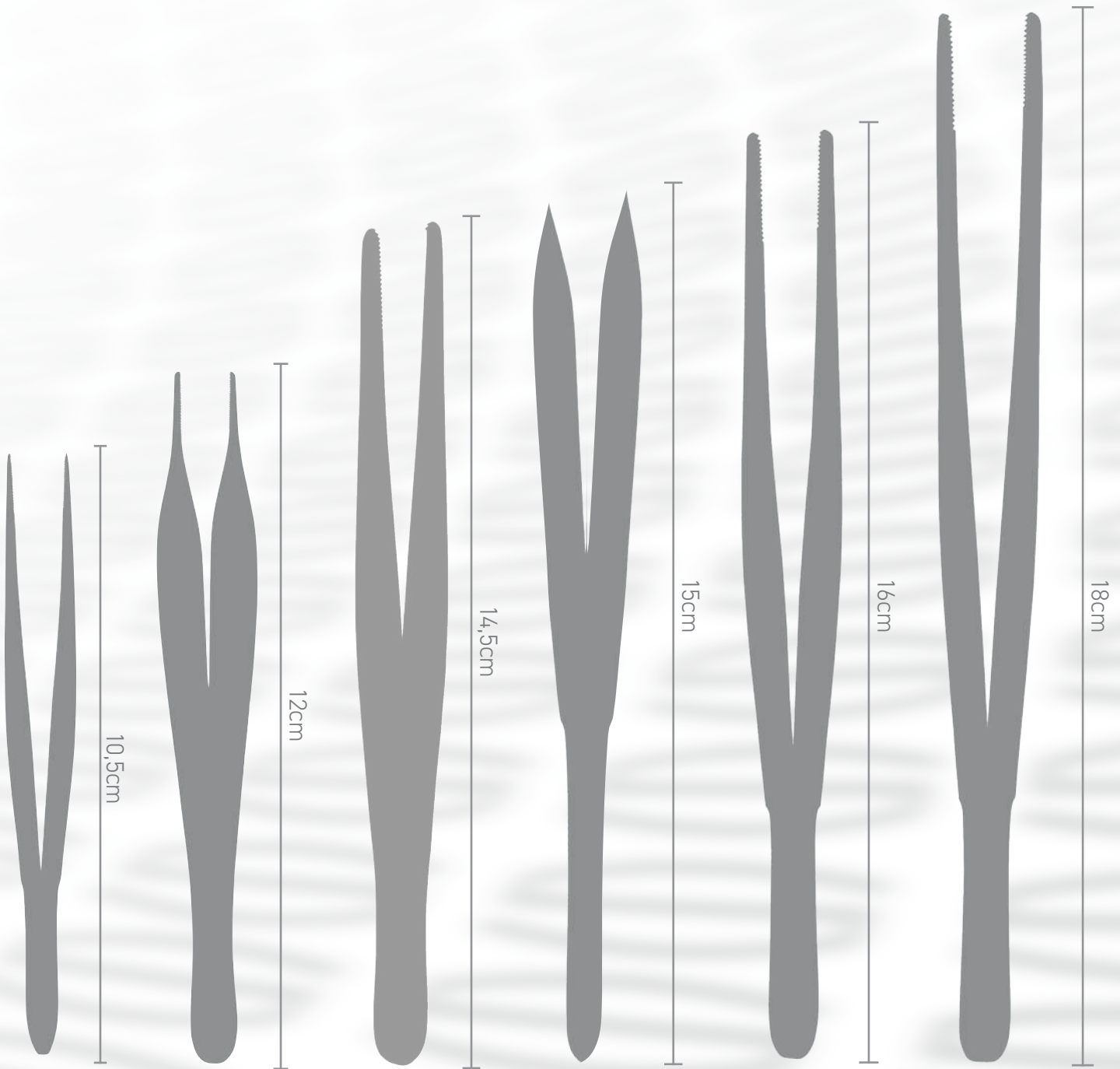

# 08

## Dissecting Forceps



1/1



1/1



1/1



1/1

Dissecting forceps,  
straight, standard

**08-020-145**

14,5cm

**08-020-160**

16cm

Dissecting forceps,  
straight, delicate

**08-030-145**

14,5cm

**08-030-160**

16cm

**08-030-180**

18cm

Dissecting forceps,  
curved, delicate

**08-033-145**

14,5cm

**08-033-160**

16cm

**08-033-180**

18cm

Dissecting forceps,  
cross-serrated

**08-036-145**

14,5cm

**08-036-160**

16cm

**08-036-180**

18cm

ADSON

SEMKEN

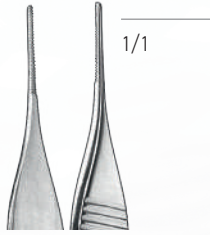

1/1

08-060-122

12 cm, delicate



1/1



1/1



1/1

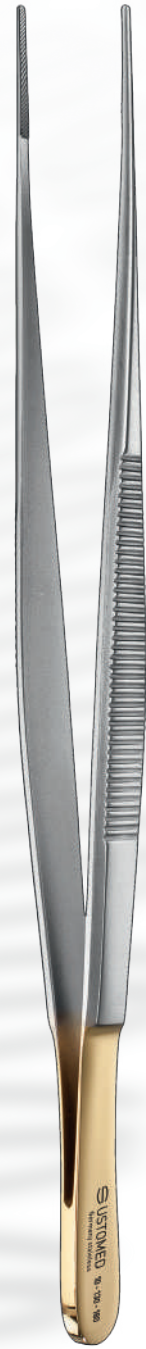

1/1

Dissecting forceps

**08-060-120**

12cm

**08-060-150**

15cm

**08-062-150**

MICRO-ADSON,  
diss. forceps, 15 cm,  
x-fine

**08-080-155**

Dissecting forceps,  
15, 5 cm, straight

**10-130-180**

Dissecting forceps,  
18 cm, delicate, TC

# 08

## Tissue Forceps

### GERALD

### SEMKEN



1/1



1/1



1/1

Tissue forceps, straight,  
1x2 t., v.delic.

**08-235-145**

14,5cm

**08-235-160**

16cm

**08-235-180**

18cm

**08-281-155**

Tissue fcps., 15, 5cm,  
straight, 1x2 t.

**08-301-175**

Tissue forceps, 17,  
5cm, str., 1x2 t.

ADSON

MICRO-ADSON

ADSON-BROWN



1/1



1/1



Tissue forceps, 1x2 teeth

**08-261-120**

12cm

**08-261-150**

15cm

Tissue forceps, 1x2 teeth, xfine

**08-262-120**

12cm

**08-262-150**

15cm

**08-267-120**

Tiss.forceps, 12cm, 7x7 teeth

09

# MICRO AND ATTRAUMATIC FORCEPS

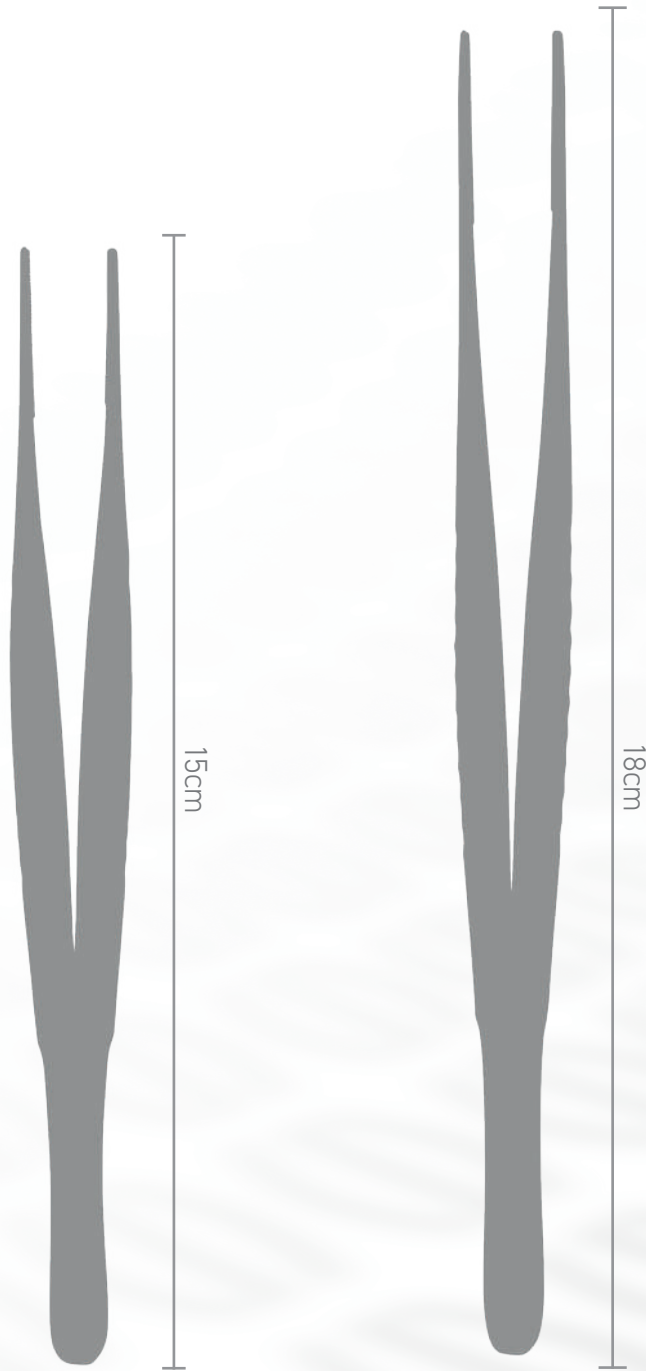



DE BAKEY



1/1



1/1



1/1

atraum. fcps., jaws 1, 5mm

**09-520-150**

15cm

**09-520-180**

18cm

atraum. fcps. jaws 2, 0mm

**09-526-150**

15cm

**09-526-180**

18cm

**09-545-150**

atraum. fcps., 15 cm,  
angled, 2mm

# 09

## Micro Forceps



1/1

**09-230-180**

Micro-dissecting forceps,  
18 cm, diamond



1/1

**09-267-180**

Micro-tissue forceps, 18 cm,  
cvd., 1, 2 mm



1/1

**09-265-180**

Micro-tissue forceps, 18 cm,  
str., 1, 2 mm

DE BAKEY



09-270-180

DE BAKEY, micro atraum.  
fcps., 18cm, str.

I'MOTION



09-280-180

I'Motion, Micro-forceps,  
Cooley,

# 10

# COLLEGE FORCEPS AND MEASURING INSTRUMENTS

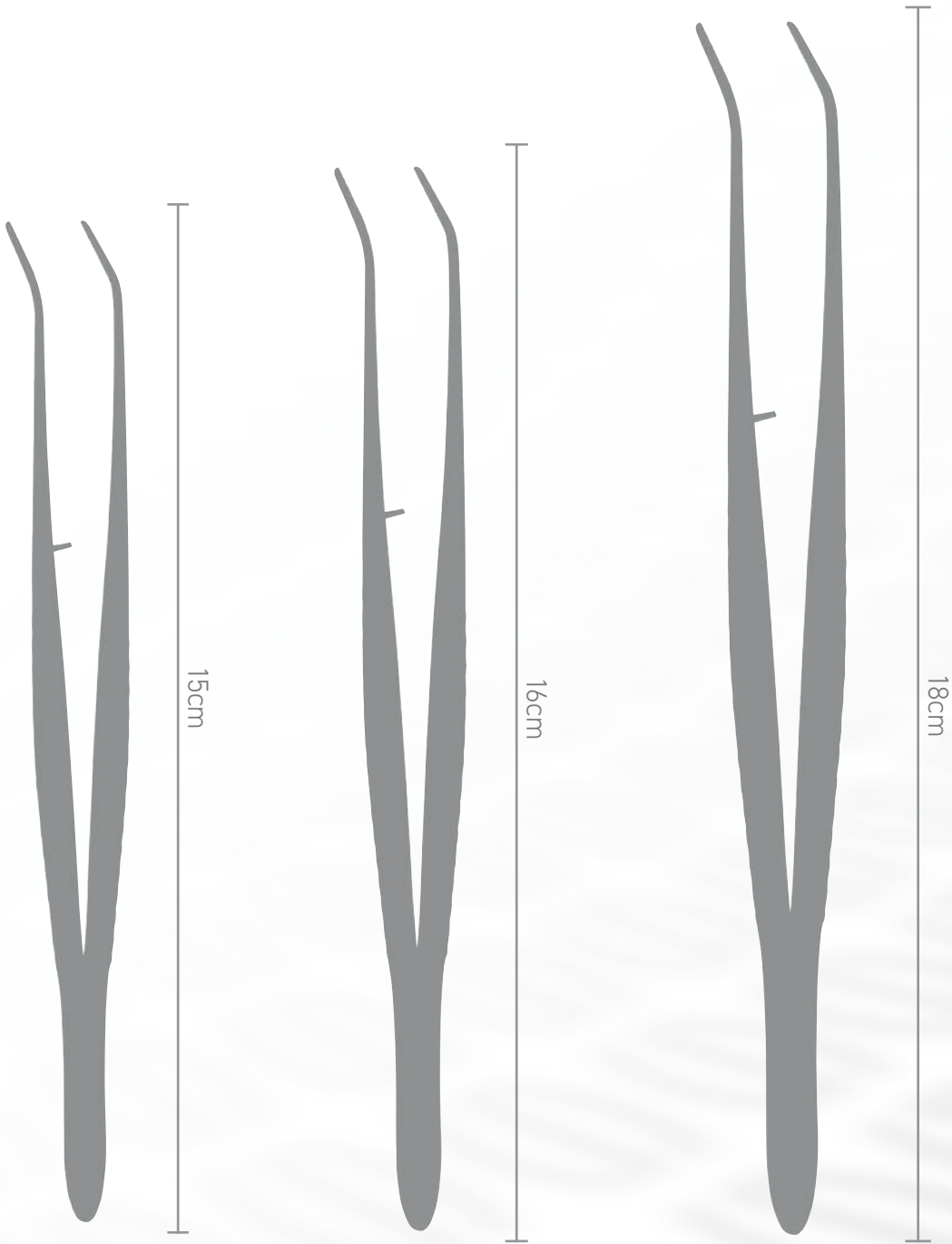

## LONDON COLLEGE

## LONDON COLLEGE modified



**10-801-150**

Tweezers, 15 cm, serrated jaws

Modif., tweezers, strong patt

**10-825-150**

15cm

**10-825-160**

16cm

**10-825-180**

18cm

**10-827-150**

Modif., tweezers, strong patt.diam

**10-829-150**

Modif., tweezers, counter-ang.

# 10

## College Forceps

### FLAGG



1/1

**10-831-160**

Tweezers, 16 cm,  
serrated jaws

### MERIAM



1/1

**10-841-160**

Tweezers, 16 cm, serrated  
jaws

**10-845-155**

Modif., tweezers, smooth  
handles



1/1

**10-130-180**

Dissecting forceps,  
18 cm, delicate, TC



1/1

Splinter forceps, 10, 5 cm,  
serr.

**08-452-105**

straight

**08-453-105**

curved



1/1

**10-823-160**

Maxgraft-Bone-Ring  
forceps, 16 cm

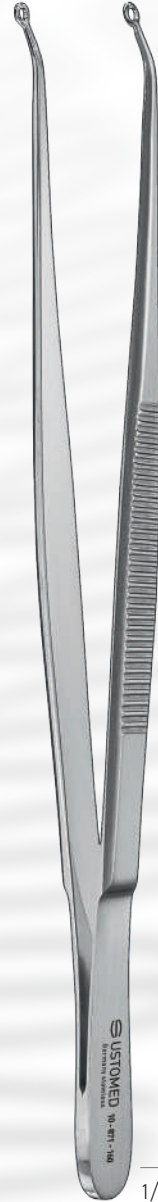

1/1

**10-871-160**

Suture forceps, 16 cm, with  
eye tips

# 10

## Special Forceps and Tweezers

### PONTE



1/1

10-877-160

PONTE, Bone-Block holding forceps, 16cm,



1/1

10-883-150

Nerve broach pliers, with lock

### MILLER



1/1

10-947-150

MILLER, forceps for articulating paper





10-941-000

IWANSON, caliper, meas. range 0-10 mm



1/1

10-942-150

Ruler, 15 cm, metal



10-943-000

ZIELINSKY, measuring caliper

# 13

# HEMOSTATIC FORCEPS



# HALSTED-MOSQUITO



1/1

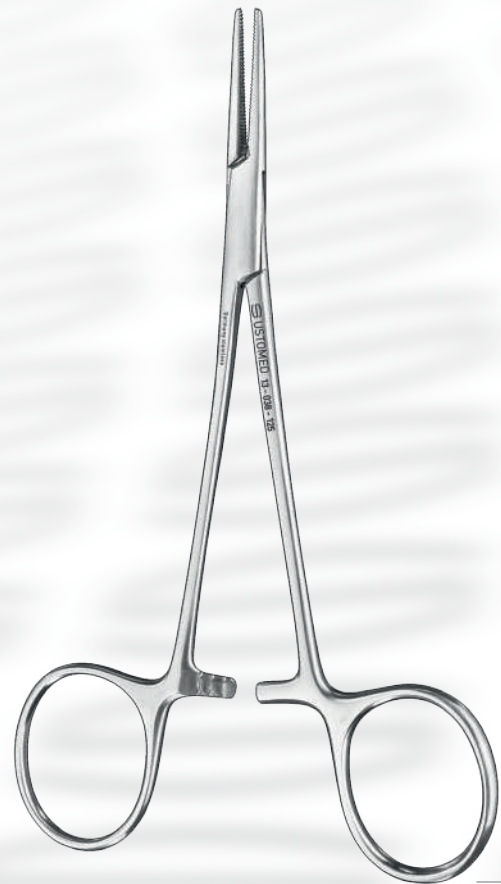

1/1

curved
<b>13-039-140</b>
14 cm
<b>13-039-125</b>
12,5 cm

straight
<b>13-038-125</b>
12,5 cm
<b>13-038-140</b>
14 cm

# 13

## Hemostatic Forceps

### ROCHESTER-PEAN

#### MICRO-MOSQUITO



13-029-120  
12 cm, curved



13-201-140  
14 cm, curved

### HALSTED-MOSQUITO



13-031-120  
12 cm, curved, 1x2 teeth

1/1

### OCHSNER-KOCHER



13-215-140  
14 cm, curved, 1x2 teeth

1/1

### MICRO-MOSQUITO



HALSTED-MOSQUITO  
13-043-125  
12,5 cm, curved  
13-043-140  
14 cm, curved  
13-042-125  
12,5 cm, straight

1/1

# 17 AUXILLARY CLAMPS AND FORCEPS



GROSS MODIFIED



1/1

**17-013-180**

Sponge holding Forceps,  
curved, with interlock

BACKHAUS



1/1

Towel Clamp

**17-251-110**

11cm

**17-251-080**

8cm

# 17

## Auxillary Clamps and Forceps



1/1

17-271-120

Towel Clamp, 12 cm,  
paper/towels

### JONES



1/1

17-227-090

Towel Clamp, 9 cm,  
curved



STIEGLITZ



1/1

**17-717-135**

Splinter forceps, angled,  
diamond-coated



1/1

Forceps, for seizing and  
steril. of instruments

**17-793-200**

20 cm

**17-790-145**

14,5 cm

# 19

# NEEDLE HOLDER



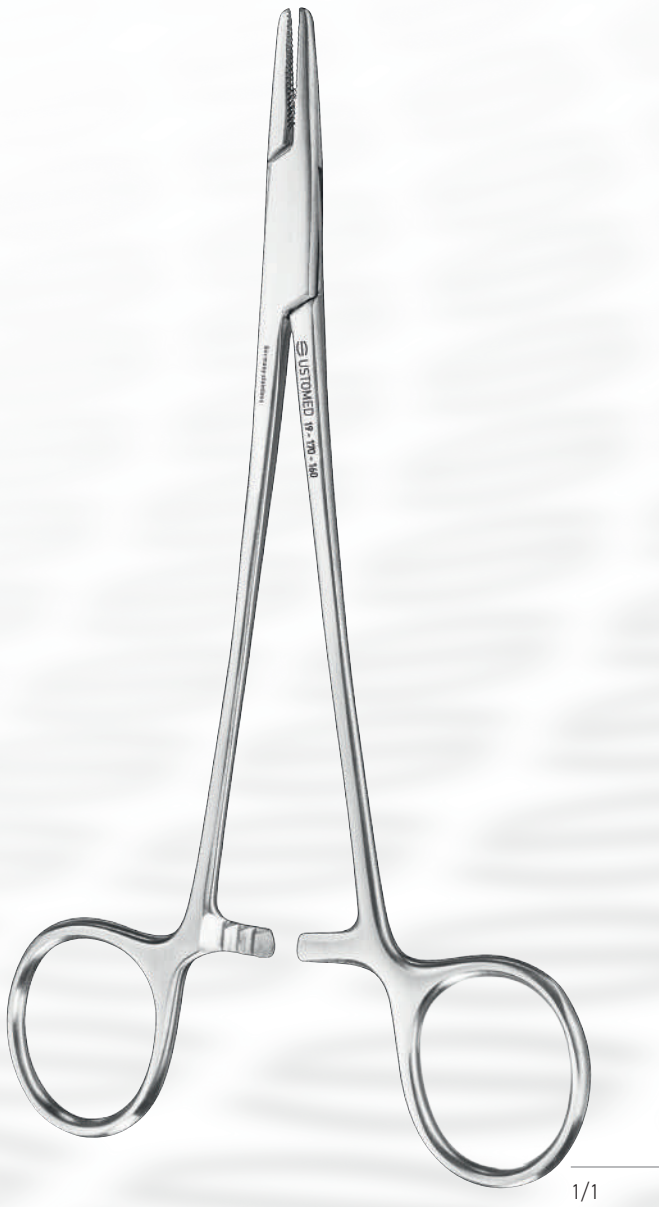

19-170-160

16 cm



19-300-140

14 cm

19-300-170

17 cm

# 20 TC NEEDLE HOLDER

## TC = TUNGSTEN CARBIDE

An extremely durable metal, that is harder than most common suture-needles! This inlay increases the longevity of our needle holders dramatically. The inlays are able to change.

The gold-plated handle indicates TC inserts.



HALSEY

BABY-CRILE-WOOD



1/1

20-120-130

13 cm

3/0 - 5/0



1/1

20-160-150

15 cm

4/0 - 5/0

# 20

TC Needle Holder

## CRILE-WOOD



20-164-150  
15 cm ) 3/0 - 5/0



20-164-180  
18 cm ) 3/0 - 5/0

MAYO-HEGAR

MICRO-RYDER



1/1

20-220-160

16 cm

) 2/0 - 4/0

20-220-180

18 cm

) 2/0 - 4/0



1/1

20-320-150

15 cm

) 5/0 - 7/0

20-320-130

13 cm

) 6/0 - 7/0

# 20

## TC Needle Holder

### MATHIEU MODIFIED



**INFO**

modified lock mechanism prevents the glove to get caught in the lock.

20-452-170	17 cm	3/0 - 4/0
20-452-140	14 cm	3/0 - 4/0
20-452-200	18 cm	3/0 - 4/0

### LICHTENBERG



20-471-170  
17 cm, curved

20-470-170	17 cm, straight	3/0 - 4/0
------------	-----------------	-----------



HÖSEL



1/1

20-480-200

20 cm, straight, extra-long

3/0 - 4/0

# 20

## TC Needle Holder

### LANGENBECK



20-392-160

16 cm

) 3/0 - 5/0

20-392-180

18 cm

) 3/0 - 5/0

### TOENNIS



20-398-180

18 cm

) 3/0 - 4/0

CASTROVIEJO



20-681-140

14 cm, curved,  
flat handle

1/1



1/1



20-681-180

18 cm, curved,  
flat handle

1/1



1/1



1/1

20-680-140

14 cm, straight,  
flat handle

5/0 - 7/0

20-680-180

18 cm, straight,  
flat handle

5/0 - 7/0

straight, round handle

20-722-160

16 cm

5/0 - 7/0

20-722-130

13 cm

5/0 - 7/0

20-722-180

18 cm

4/0 - 6/0

# 20

## TC Micro-Needle Holder

### BARRAQUER



20-710-140

14 cm, straight,  
round handle

5/0 - 7/0

20-710-180

18 cm, straight,  
round handle

5/0 - 7/0

20-711-140

14 cm, curved,  
round handle

5/0 - 7/0

20-711-180

18 cm, curved,  
round handle

5/0 - 7/0

I'MOTION



1/1



1/1

20-752-180

18 cm, straight

**INFO**

- extremely light
- plasma-coated tips
- easy to clean

20-753-180

18 cm, curved

5/0 - 7/0

# 24

# RETRACTORS



GILLIES

KILNER



24-421-150

15 cm, 1 fork, sharp



Fig. 1

24-425-001

18 cm, size 1, small



Fig. 2

24-425-002

18 cm, size 2, large

# 24

## Tissue Retractors

### JOSEPH

### GUTHRIE



24-469-002

15 cm, 2 forks, sharp



24-573-002

16 cm, 2 forks, 2 mm



24-573-007

16 cm, 2 forks, 7 mm





24-021-001

single fork, 16 cm, sharp

24-021-002

double fork, 16 cm, sharp

24-023-001

single fork, 16 cm, blunt

# 24

## Cheek Retractors

### MINI- LANGENBECK

### CAWOOD- MINNESOTA

### GIERL



24-153-000  
Cheek Retractor

24-154-160  
16 cm

24-157-155  
15,5 cm



84-239-000

GLUCKMANN, PET-Shield holder, double-sided



**INFO**

Special tool for the Advanced Socket Shield Technique: „PET“ by Dr. Howard Gluckman.

Helps you to secure the gingiva, when preparing the buccal root during the procedure.



24-158-002

PET Shield, right



24-158-001

PET Shield, left

# 24

## Cheek Retractors

## MIDDELDORPF

### HILGER



24-159-001

Cheek Retractor,  
only, compatible  
to mouth mirror  
handles

24-159-000

Cheek Retractor,  
complete with handle



24-161-002

22 cm, size 2, medium

LANGENBECK



1/2

Wound Retractor  
21 cm

KOCHER

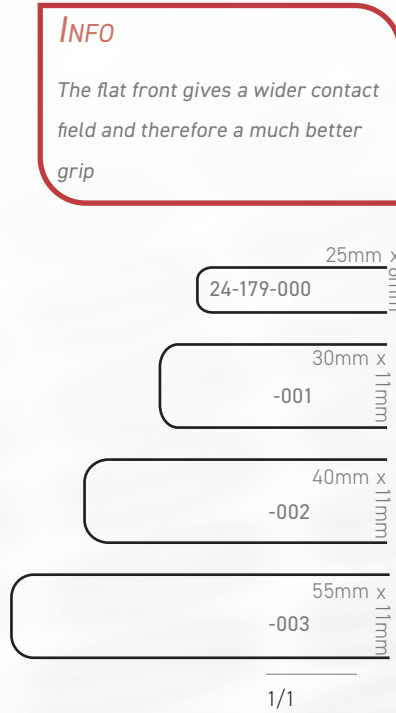

1/2

Wound Retractor  
22 cm

OBWEGSER

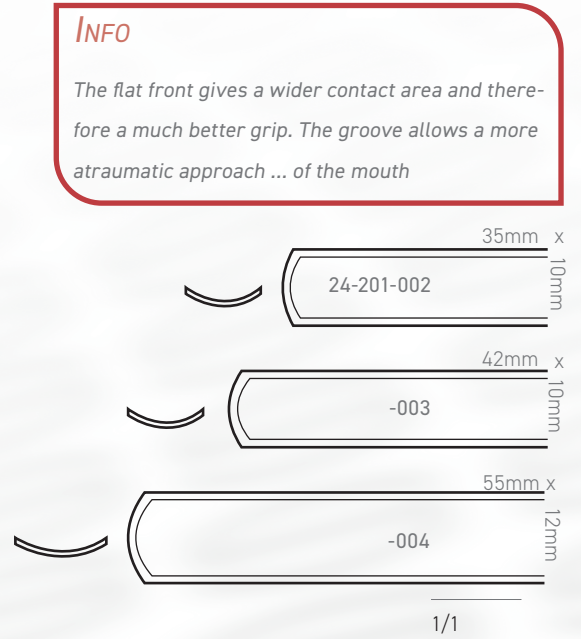

1/2

Wound Retractor  
24 cm

INFO

The flat front gives a wider contact field and therefore a much better grip

INFO

The flat front gives a wider contact area and therefore a much better grip. The groove allows a more atraumatic approach ... of the mouth

# 24

## Wound & Special Retractors

### NENTWIG

#### KOCHER-TROSSBACH



24-179-103

size 3, 55 x 11mm,  
bended upwards



24-191-230

Zygomatic Retractor,  
23 cm



24-191-014

Special Retractor,  
70x14mm, serrated

USTOMED

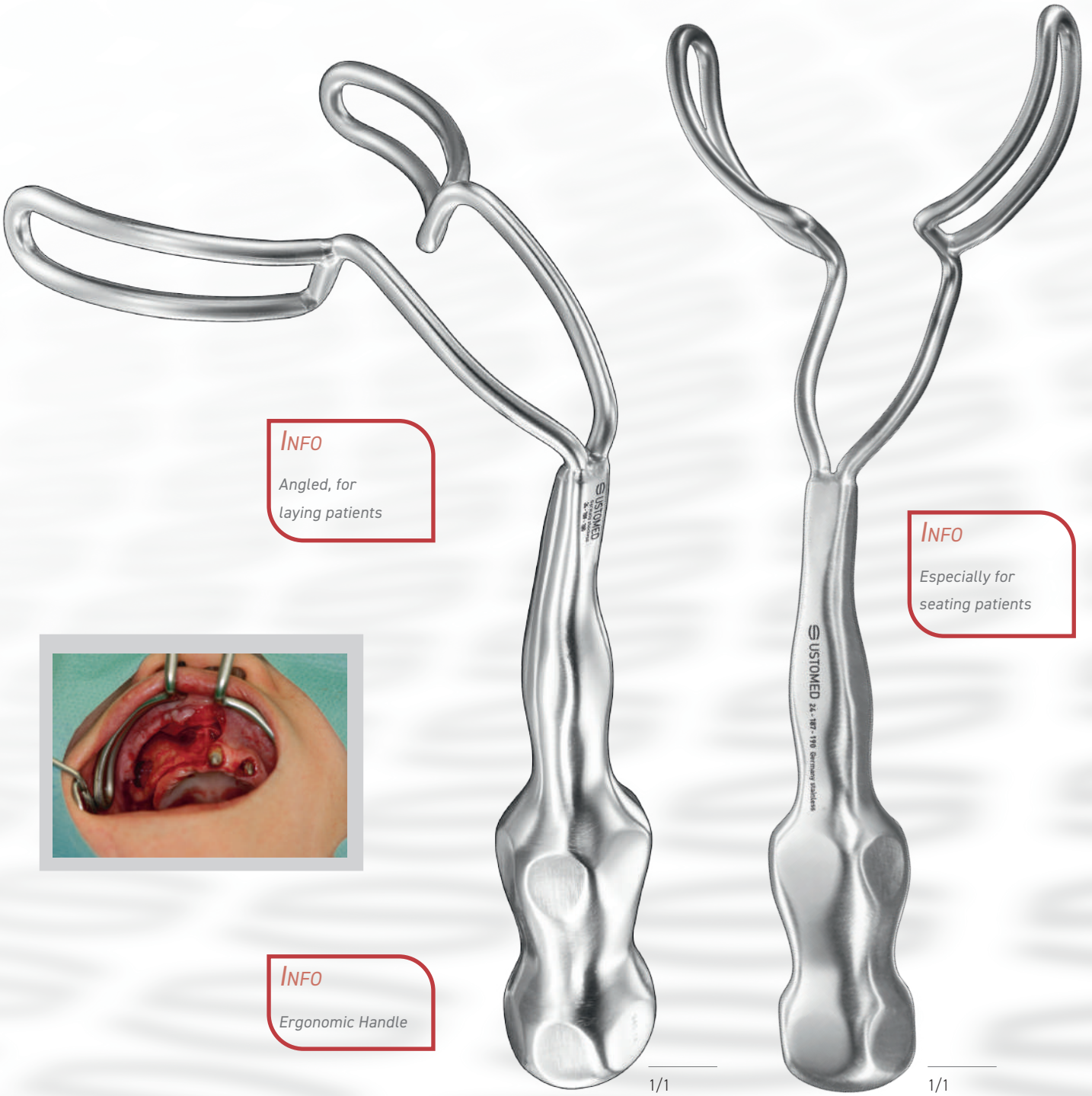

**INFO**  
 Angled, for  
 laying patients

**INFO**  
 Especially for  
 seating patients

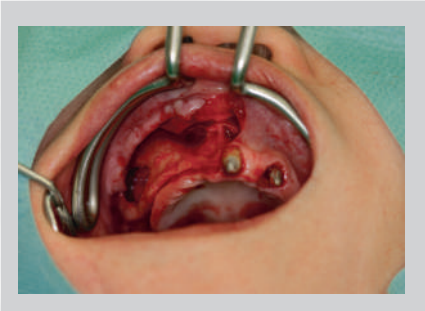

**INFO**  
 Ergonomic Handle

1/1

1/1

24-189-180  
 universal, angled

24-187-190  
 universal, straight

### LASTER

### BRAANEMARK



1/1

24-186-150

80mm



1/1

24-203-105

Retractor, for upper impacted wisdom



HILGER

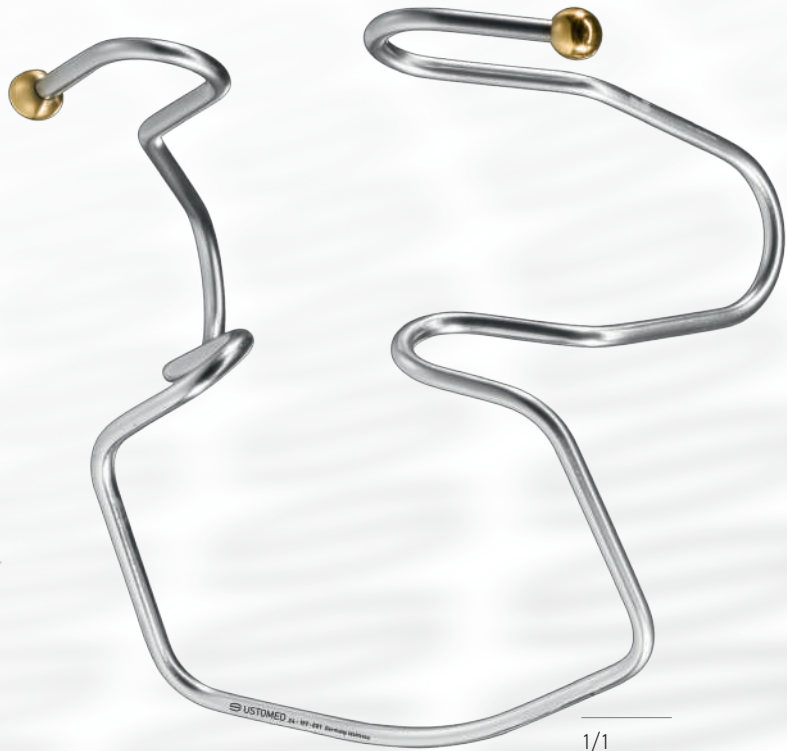

24-197-001

cheek and lip spreader,  
size 1

1/1



24-197-002

cheek and lip spreader,  
size 2

1/1

# 24

## Cheek and Lip Spreaders

### SPANDEX

#### INFO

Cheek and lip spreaders self-expanding, plastic material, autoclavable up to 180° C.



24-395-001

size 1, pack of 2



24-395-002

size 2, pack of 2

# 27

# ELEVATORS AND RASPATORIES



# 27

## Elevators and Raspatories

## OBWEGESER

### WILLIGER



27-741-160

Raspatory,  
16 cm,  
curved

27-745-160

Raspatory,  
16 cm,  
curved, wide

27-743-130

Raspatory,  
13 cm,  
curved

27-749-006

Raspatory,  
17,5 cm, 6mm

## FREER



**27-451-180**

Elevator, 18 cm, double-ended, sharp/blunt

**27-451-180P0T3**

Elevator, 18 cm, double-ended, sharp/blunt, peek handle

## PRICHARD



**27-459-175**

Raspatory PR3, 17,5 cm, double-ended

**27-459-175P0T3**

Raspatory PR3, 17,5 cm, double-ended, peek handle



**27-717-175**

Raspatory, 17,5 cm, double-ended, curved

**27-717-175P0T3**

Raspatory, 17,5 cm, double-ended, curved, peek handle

# 27

## Elevators and Raspatories

### MOLT

### GLICKMAN



27-711-024

Raspatory No.24G, 16,5 cm



27-721-190

Raspatory, 19 cm,  
double-ended, curved

ZUCHELLI

USTO-SOFT-  
GRIFF

USTOMED



**INFO**  
black coated tips, allow  
better visuability under  
gingiva

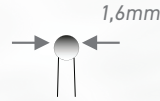

85-814-175P0T3

 Mod. Z, peek handle

85-812-175P0T3

Mod. W, peek handle

85-812-175

Mod. W

## KASAJ

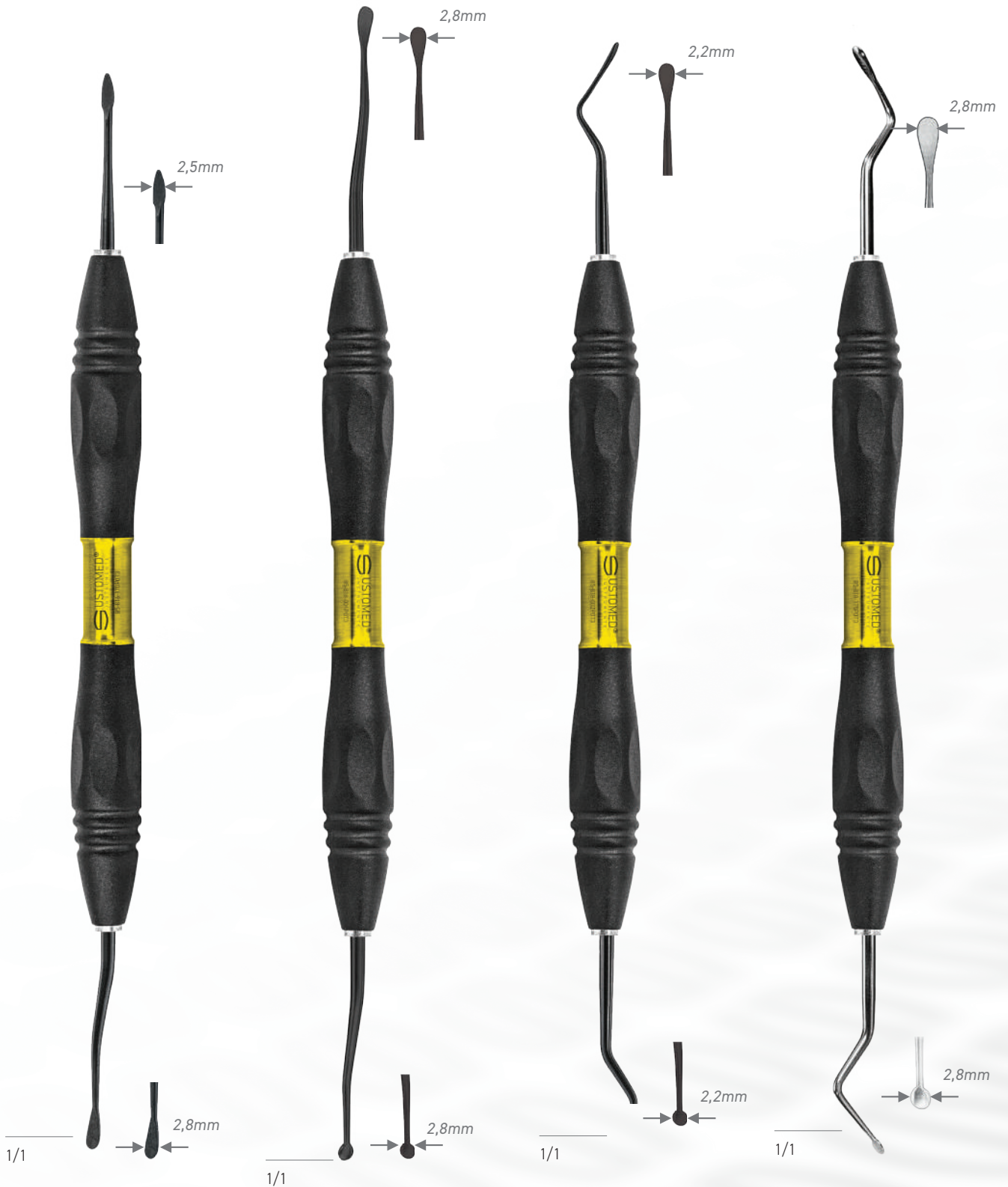

85-816-170P0T3

Mod. B, micro

85-818-001P0T3

Tunnelling knife,  
micro, 20cm,  
posterior

85-818-002P0T3

Tunnelling knife,  
micro, 19cm,  
anterior

85-818-175P0T3

Tunnelling knife,  
19 cm, anterior



## USTO-SOFT-GRIP



1/1



1/1



1/1



1/1



**85-816-175**

Mod. B, 17,5 cm

**85-816-175POT3**

Mod. B, 17,5 cm

**85-808-175POT3**

Mod. W, 18,5 cm

**85-808-175**

Mod. W, 17,5 cm

31

# BONE RONGEURS



## MICRO

## FRIEDMAN

## LUER



**INFO**  
For granulation tissue,  
not for bone!

1/1



1/1



1/1

31-319-145

14cm / 25° curved

31-321-140

Bone rongeur, 14 cm,  
curved

31-379-150

16 cm, curved, medium

# 31

## Bone Rongeurs

BEYER

DELICATE



1/1

31-315-150

15 cm, curved



1/1

31-421-180

Bone Rongeur, 18 cm,  
curved, transmitted

**INFO**

Less force required,  
due to transmission.

# 42

# MEASURING DEVICES

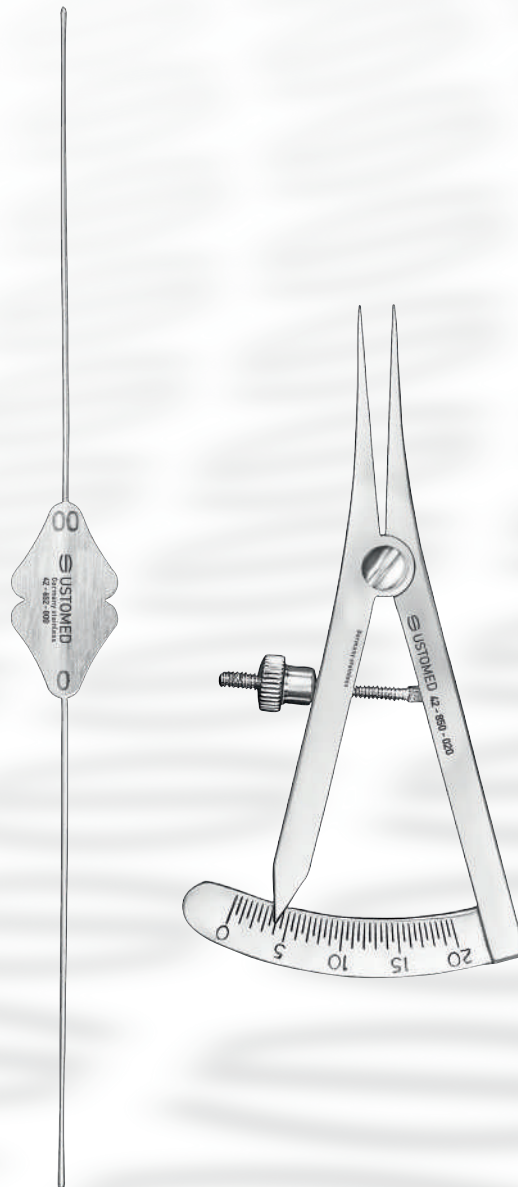

### BOWMAN



1/1

Antrum probe, ball-point

**42-652-000**  
size 00/0



**42-652-012**  
size 1/2



**42-652-034**  
size 3/4



**42-652-056**  
size 5/6



**42-652-078**  
size 7/8



**42-652-300**  
sz.000/00



**42-652-400**  
0000/000

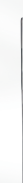

### CASTROVIEJO

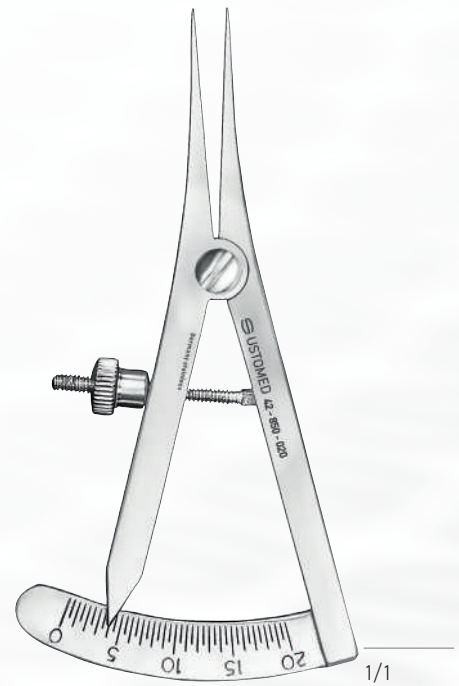

1/1

**42-850-020**

Implantology caliper,  
20 mm, straight

# 46 SINUS CURETTES



# 46

## Sinus Curettes

### KHOURY

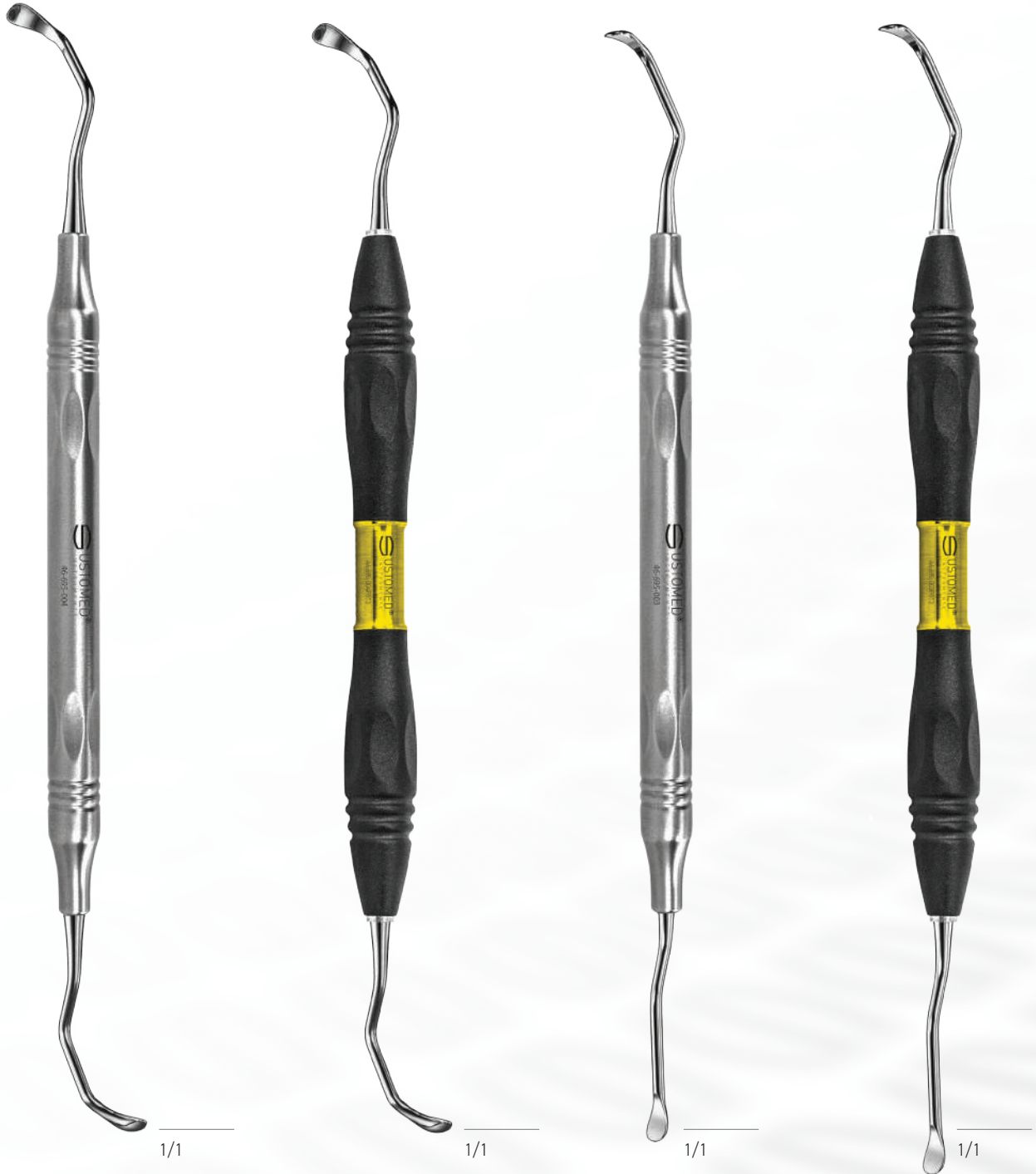

**46-695-004**

Sinus Curette,  
Fig. 4, 180 mm,  
semi-sharp

**46-695-004POT3**

Sinus Curette, Fig. 4,  
180 mm, semi-sharp,  
peek handle

**46-695-003**

Sinus Curette,  
Fig. 3, 180 mm,  
semi-sharp

**46-695-003POT3**

Sinus Curette, Fig. 3,  
180 mm, semi-sharp,  
peek handle



HOTZ

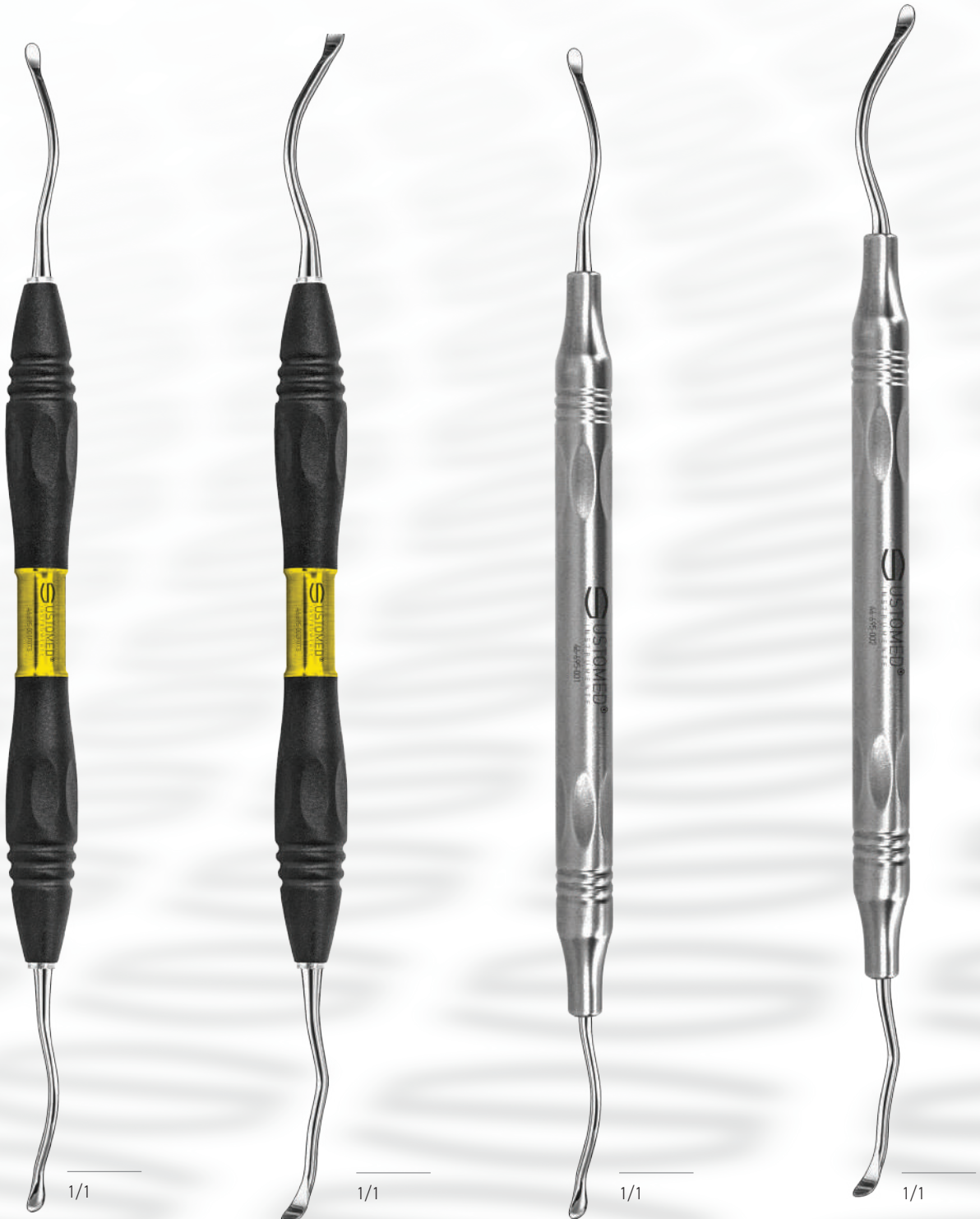

**46-695-001POT3**

Sinus Curette, Fig. 1,  
185 mm, semi-sharp,  
peek handle

**46-695-002POT3**

Sinus Curette, Fig. 2,  
190 mm, semi-sharp,  
peek handle

**46-695-001POT3**

Sinus Curette, Fig. 1,  
185 mm, semi-sharp

**46-695-002POT3**

Sinus Curette, Fig. 2,  
190 mm, semi-sharp

# 46

## Sinus Currettes

### NENTWIG

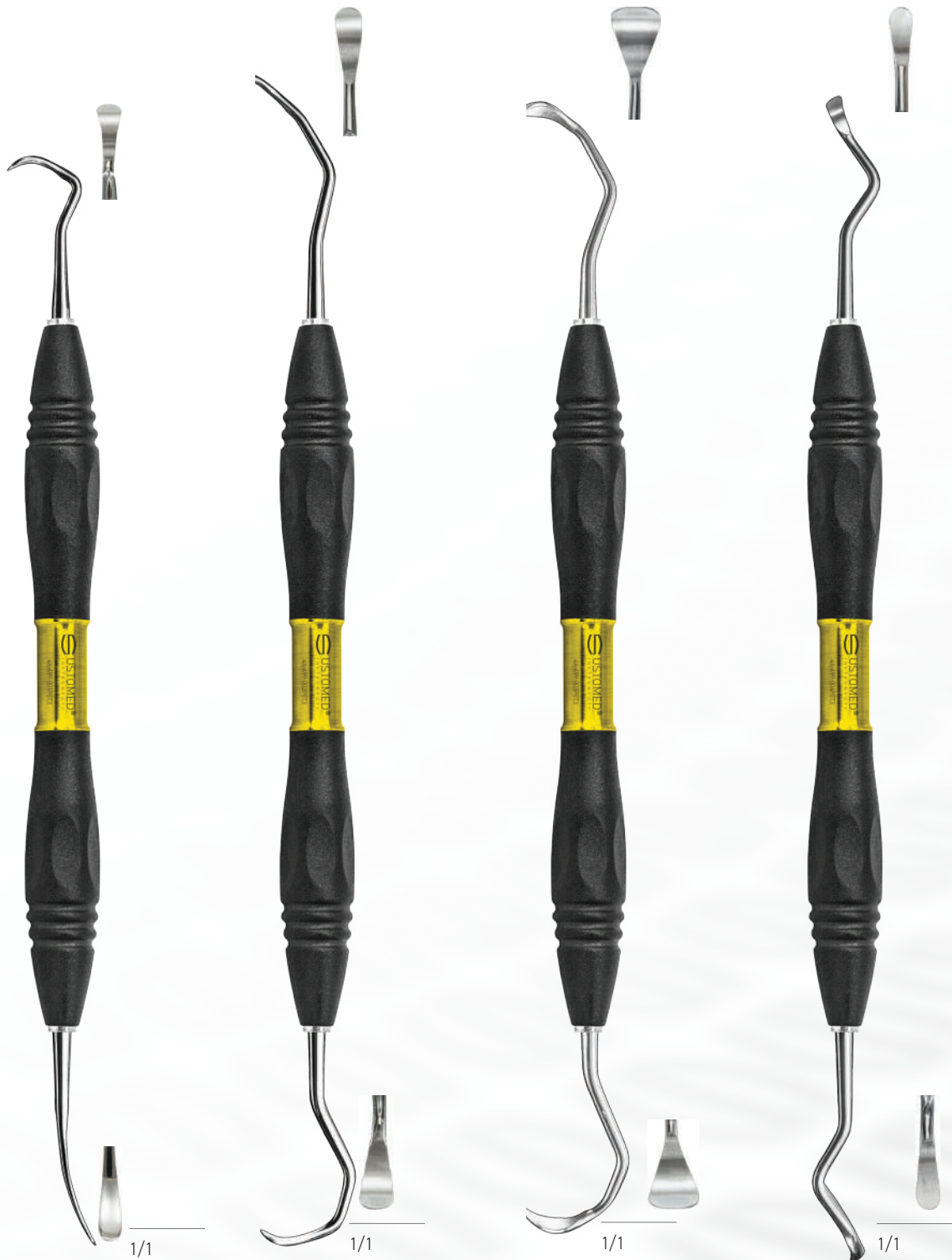

**46-699-001P0T3**

Sinus Curette, Fig. 1,  
180 mm, sharp, peek  
handle

**46-699-002P0T3**

Sinus Curette, Fig. 2,  
190 mm, sharp, peek  
handle

**46-699-003P0T3**

Sinus Curette, Fig. 3,  
190 mm, sharp, peek  
handle

**46-699-004P0T3**

Sinus Curette, Fig. 4,  
190 mm, sharp, peek  
handle

# 48 MOUTH WEDGES, GAGS & PACKING INSTRUMENTS



# 48

## Mouth Wedge



48-081-001

Mouth Wedge, plastic, size M



48-081-002

Mouth Wedge, plastic, size L

48-149-200

Silicone tube, 2 m,  
sterilizable, compatible  
with 48-141-140, 48-145-  
120, 48-149-000

## MOLT



48-141-140

Mouth gag, 14 cm, for  
adults

## DENHART



48-145-120

Mouth gag, 12 cm, fine ratchet

# 48

## Mouth Gag

48-149-200

Silicone tube, 2 m,  
sterilizable, compatible  
with 48-141-140, 48-145-  
120, 48-149-000

USTOMED



1/1

48-149-000

Set, complete, DBGM



1/1

48-149-001

Scoop for 48-149-000,  
single part, for children



1/1

48-149-002

Scoop for 48-149-000,  
single part, for adults

HABERER

BRUENINGS

TOBOLD



1/1

48-260-200

Tongue depressor, 20 cm, 17x25 mm, bendable



1/1

48-255-190

Tongue depressor, 19 cm



1/1

48-271-165

Tongue depressor, 16,5 cm

# 48

## Packing Instruments

### LUNIATSCHEK



48-339-002

wide

#### INFO

*Points slightly rounded, hence less traumatizing and less painful for the patient.*

1/1

48-339-001

Gauze Packer, narrow, 17,5 cm



48-351-165

serrated

#### INFO

*Very thin and flexible working ends slightly twisted in themselves, thus making possible to operate more simply and more carefully than with the conventional method using the Heidemann spatula.*

1/1

48-349-165

Retraction thread packer, smooth



1/1

48-353-165

Retraction thread packer, plate form



# 67/68 BONE PREP INSTRUMENTS AND TOOLS



# 67

## Plugger

### DEGIDI



1/1

**67-693-012P0T3**

DEGIDI Plugger,  
size 1/2, peek  
handle



1/1

**67-693-034P0T3**

DEGIDI Plugger,  
size 3/4, peek  
handle

#### INFO

Special instruments for  
filling and condensing bone  
material around an implant.

## RHODES



1/1

**67-545-367POT3**

Back-Action Chisel,  
size 36/37, peek  
handle



1/1

**85-802-305POT3**

Bone Scraper, Mod.  
B, 3 and 5 mm  
width, peek handle



1/1

**67-691-003POT3**

Filler and Plugger for  
biomaterials, peek  
handle



1/1

**67-691-008POT3**

Filler and Plugger for  
biomaterials, peek  
handle

### MINI-LAMBOTTE

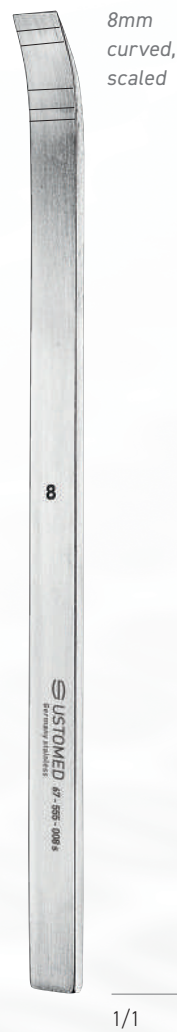

**67-555-004 S**

13 cm, 4 mm,  
curved, scaled

**67-554-004S**

13 cm, 4 mm,  
curved, scaled

**67-555-006 S**

13 cm, 6 mm,  
curved, scaled

**67-554-006S**

13 cm, 6 mm,  
curved, scaled

**67-555-008 S**

13 cm, 8 mm,  
curved, scaled

**67-554-008S**

13 cm, 8 mm,  
curved, scaled

**67-555-010 S**

13 cm, 10 mm,  
curved, scaled

**67-554-010S**

13 cm, 10 mm,  
straight, scaled



### NENTWIG

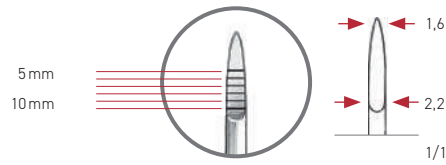

**67-558-001**  
size 1, straight, scaled

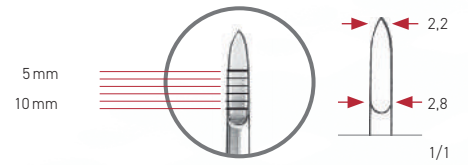

**67-558-002**  
size 2, straight, scaled

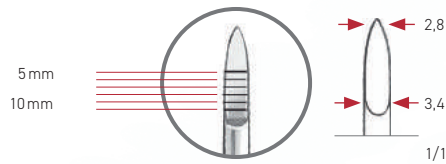

**67-558-003**  
size 3, straight, scaled

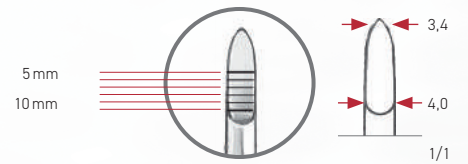

**67-558-004**  
size 4, straight, scaled

Localized spreading of the narrow ridge



**67-558-444**

Set, size 1-4, straight, scaled

# NENTWIG



1/1

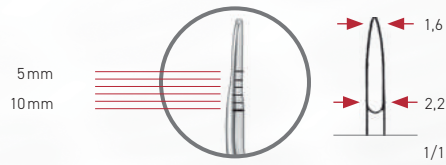

**67-559-001**

size 1, bajonet, scaled

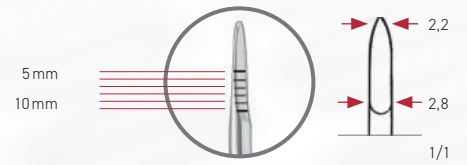

**67-559-002**

size 2, bajonet, scaled

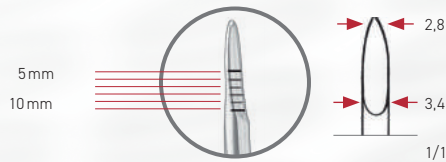

**67-559-003**

size 3, bajonet, scaled

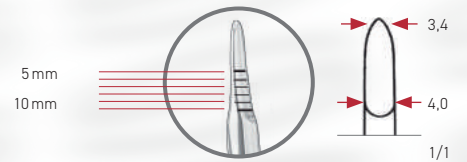

**67-559-004**

size 4, bajonet, scaled

Condensing: preparation of the implant site when bone structure is compromised



**67-559-444**

Set, size 1-4, bajonet, scaled

# 67

Bone Mill

## USTOMED BONE MILL



Mill, complete Set, with Cutting Cylinder and Collector

**67-682-002**

size S

**67-682-003**

size M

**67-682-004**

size L





67-682-012

Cutting Cylinder, size S,  
ca. 2 mm bone flakes



67-682-013

Cutting Cylinder, size M,  
ca. 3 mm bone flakes

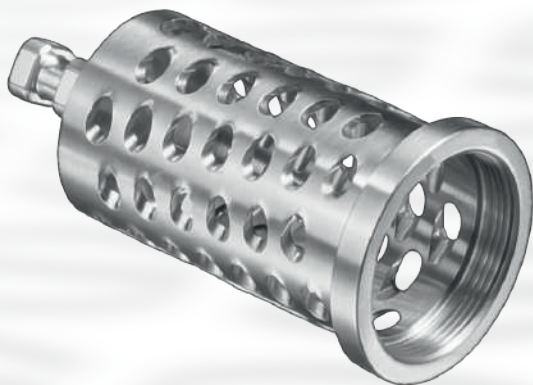

67-682-014

Cutting Cylinder, size L,  
ca. 4 mm bone flakes



67-682-020

Collector

# 67

## Mallets

### INFO

exchangeable  
teflon inlays

67-636-002

Teflon Discs, for  
67-636-210, 2 pcs.

### INFO

Completely  
made from steel

### INFO

Most common  
mallet for use  
with pins



67-660-150

16,5 cm, 150 g



67-636-210

18,5 cm, 210 g, Ø 25 mm

OMBREDANNE



1/1

67-670-720  
26 cm, 720 g

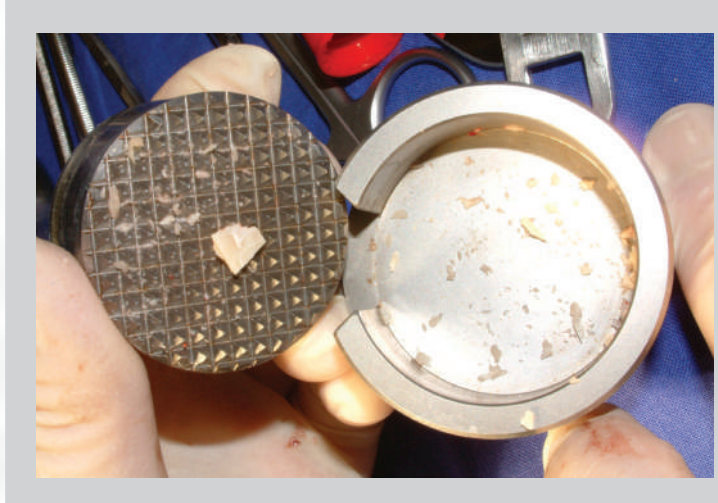

Photo Copyright Dr. Ponte



1/1

67-680-000  
Bone crusher, round

# 67

## Bone Curettes

### LUCAS

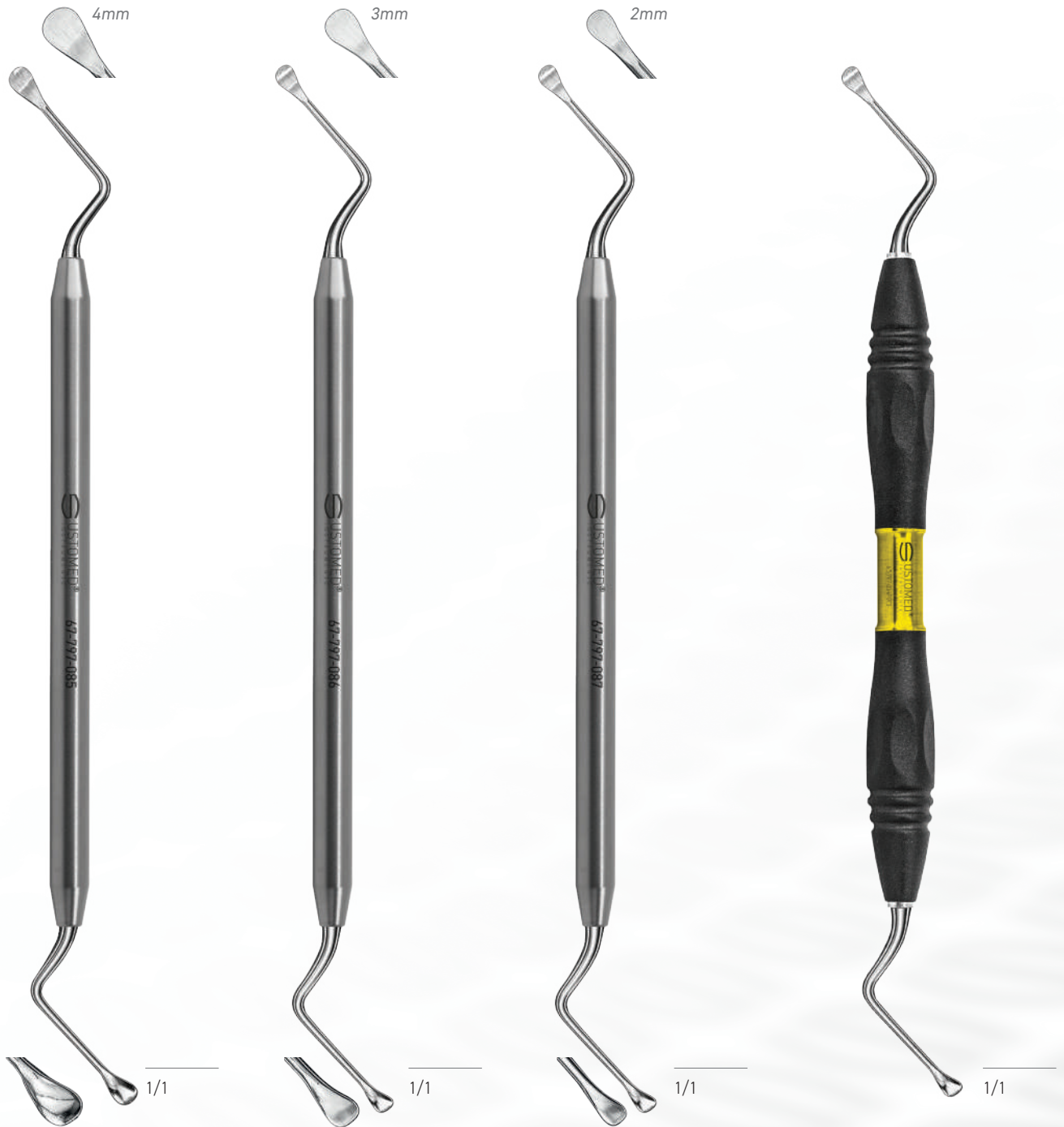

**67-797-085**

size 85, 17 cm,  
double-ended

**67-797-085P0**

peek handle

**67-797-086**

size 86, 17 cm,  
double-ended

**67-797-086P0**

peek handle

**67-797-087**

size 87, 17 cm,  
double-ended

**67-797-087P0**

peek handle

**67-797-186P0T3**

peek handle

# HEMINGWAY



18cm, double-ended

**67-799-000**  
size 0



**67-799-010**

size 1



**67-799-020**

size 2



**67-799-030**

size 3



**67-799-040**

size 4



**67-799-010P0**

size 1



**67-799-020P0**

size 2



**67-799-030P0**

size 3



**67-799-040P0**

size 4



1/1

18cm, double-ended

**67-799-000P0**  
size 0



1/1

# 67

## Bone Condenser, Osteotomes

**INFO**  
Suitable for internal Sinus Lift.

**INFO**  
Infinitely variable adjustment.



67-851-030  
Ø 3,0 mm



67-851-033  
Ø 3,3 mm



67-851-040  
Ø 4,0 mm

Bone Condenser, bajonet, concave, Ø 2,0 mm

67-851-020

# USTOMED TITAN-PIN-SET

**68-780-018**  
Titan-Pin-Set, complete



## SET INCLUDES:



## TITAN-PINS

**68-620-003**  
Titan-Pins, 3mm, 10 pcs.

**INFO**  
Suitable mallet 67-660-150  
(see page 98)

## APPLICATOR

- Single-piece instruments to collect the pins from the holding tray therefore the twisting of the working tip during the operation is excluded.
- Very ergonomical and comfortable Grip for a safe operation of the Titan-Pins

**68-650-000**  
Applicator, for pins 68-620-003, 15,5cm

## HOLDING TRAY

- Functional Design
- safe and easy to operate with single hand principle
- Box can contain up to 15 Titan-Pins

**68-720-008**  
Box for 15 Titan-Pins

**68-780-016**

Bone-Fixation-Set, Titan,  
1,2mm / 1,4mm Ø

**CONTENTS:**

- 68-720-002 Box for Micro-Screws Ø 1,0/ 1,2/ 1,4mm
- 68-740-002 Screwdriver, 11cm, Fig. 2
- 68-760-102 Blade, cross, self-retaining, 60mm length, for 68-740-002
- 68-510-014 Pilot drill, Ø 1, 0mm, 14mm
- 68-512-014 Pilot drill, Ø 1, 2mm, 14mm
- 68-112-008 Titanium, Ø 1,2mm, 8mm length, cross, 10 pcs.
- 68-115-004 Membrane Screws, selfcutting, 4mm, 10 pcs.

**MATCHING ITEMS:****Accessories:**

- 68-720-002 Box for Micro-Screws Ø 1,0/ 1,2/ 1,4mm
- 68-740-002 Screwdriver, 11cm, Fig. 2
- 68-760-106 Blade, cross, self-retaining, short, for Contra-Angle HP

**Pilot Burs:**

- 68-510-014 Pilot drill, Ø 1, 0mm, 14mm
- 68-512-014 Pilot drill, Ø 1, 2mm, 14mm
- 68-514-014 Glide Hole drill, Ø 1, 4mm, 14mm

**Micro Screws (10 pcs. per Pack):**

- 68-112-006 Titanium, Ø 1,2mm, 6mm length, cross, 10 pcs.
- 68-112-008 Titanium, Ø 1,2mm, 8mm length, cross, 10 pcs.
- 68-112-011 Titanium, Ø 1,2mm, 11mm length, cross, 10 pcs.
- 68-112-013 Titanium, Ø 1,2mm, 13mm length, cross, 10 pcs.
- 68-114-006 Titanium, Ø 1,4mm, 6mm length, cross, 10 pcs.
- 68-114-008 Titanium, Ø 1,4mm, 8mm length, cross, 10 pcs.
- 68-114-011 Titanium, Ø 1,4mm, 11mm length, cross, 10 pcs.
- 68-114-013 Titanium, Ø 1,4mm, 13mm length, cross, 10 pcs.
- 68-115-004 Membrane Screws, selfcutting, 4mm, 10 pcs.



**68-780-010**

Bone-Fixation-Set, Steel,  
1,0mm Ø



**CONTENTS:**

- 68-720-002 Box for Micro-Screws Ø 1,0/ 1,2/ 1,4mm
- 68-740-002 Screwdriver, 11cm, Fig. 2
- 68-508-014 Pilot drill, Ø 0, 8mm, 14mm
- 68-110-011 S Steel, Ø 1,0mm, 11mm lenght, cross, 10 pcs.

**MATCHING ITEMS:**

**Accessories:**

- 68-720-002 Box for Micro-Screws Ø 1,0/ 1,2/ 1,4mm
- 68-740-002 Screwdriver, 11cm, Fig. 2
- 68-760-106 Blade, cross, sefl-retaining, short, for Contra-Angle HP

**Pilot Burs:**

- 68-508-014 Pilot drill, Ø 0, 8mm, 14mm
- 68-510-014 Pilot drill, Ø 1, 0mm, 14mm

**Micro Screws (10 pcs. per Pack):**

- 68-110-008 S Steel, Ø 1,0mm, 8mm lenght, cross, 10 pcs.
- 68-110-011 S Steel, Ø 1,0mm, 11mm lenght, cross, 10 pcs.
- 68-110-013 S Steel, Ø 1,0mm, 13mm lenght, cross, 10 pcs.

## BOX FOR MICRO SCREWS AND ACCESSORIES

- Sophisticated and functional Design
- Integrated ruler for the exact determination of screw and graft lengths (removable)
- Newly-developed Material by Aerospace Engineering  
- THERMOSTABLE
- All parts are suitable for machine processing in the thermodisinfector as well as for all conventional methods, thus corresponding to the latest „RKI - Guidelines“
- Collection tray for all Ustomed screw sizes-diameter (1,0 mm to 1,4 mm)

## SCREW DRIVER

- perfect handle length – therefore suitable for all hand sizes
- The ergonomic handle allows a comfortable and fatigue-free operation
- Self-holding mechanism for collecting screws





Foto: Dr. Jan Kielhorn



## INNOVATIVE GEOMETRY OF THE MICRO SCREWS

- Precisely milled cross-slit screw head
- all screw types (1,0mm bis 1,4mm) are to be collected with the same blade
- Fast and safe collection of the self-holding micro screws
- Extreme friction between screw head and blade, prevents wear-and-tear
- Much easier removal of debris from the cross-slit (in comparison to inner four-edge or Torx)

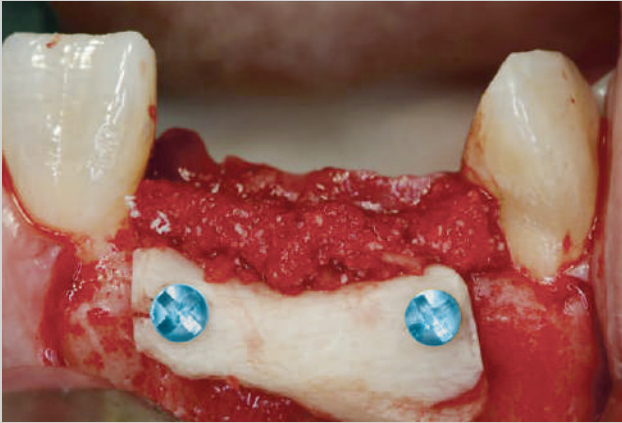

Foto: Dr. Stephan Beuer, M.Sc.



### TITANIUM MICRO SCREWS

- diameter: 1,2 mm / 1,4 mm
- length: 6 mm / 8 mm / 11 mm / 13 mm

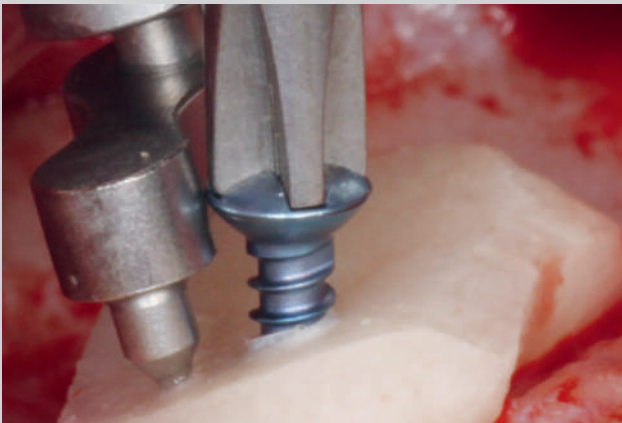
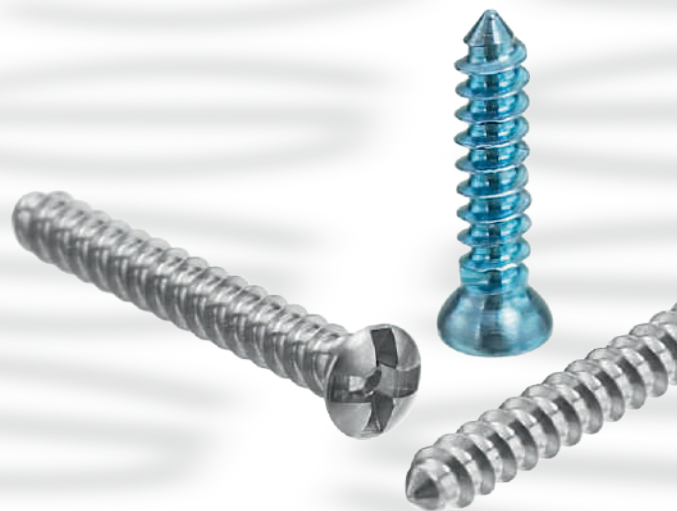
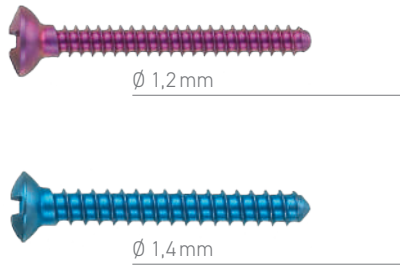

### IMPLANT-STEEL ALLOY MICRO SCREWS

- diameter: 1,0 mm
- lengths: 8 mm / 11 mm / 13 mm
- perfectly suited for very small bone grafts and 3D-Augmentations
- special alloy material prevents Osseointegration and therefore a dramatically reduced danger of breaking the screws in comparison to titanium screws of similar lengths

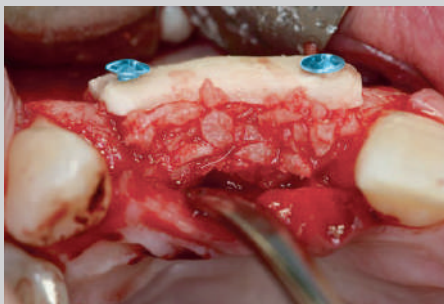
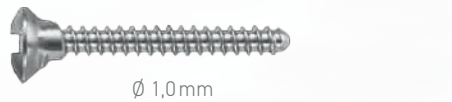

Photo: Jan Kielhorn

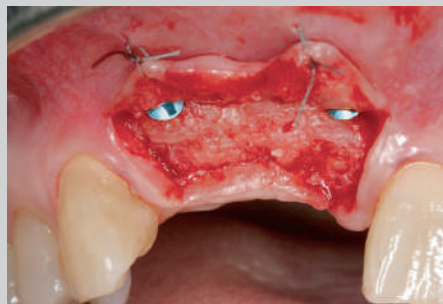

Photo: Jan Kielhorn

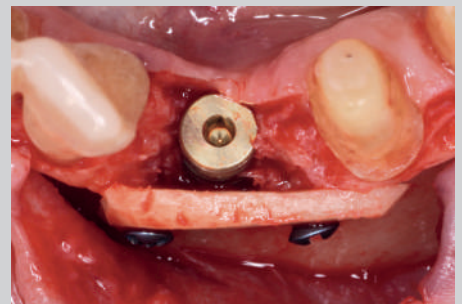

Photo: Dr. Stephan Beuer, M. Sc.



Photo: Dr. Stephan Beuer, M. Sc.

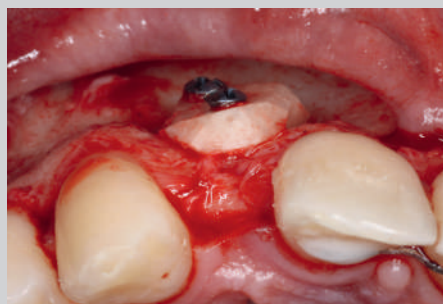

Photo: Dr. Stephan Beuer, M. Sc.

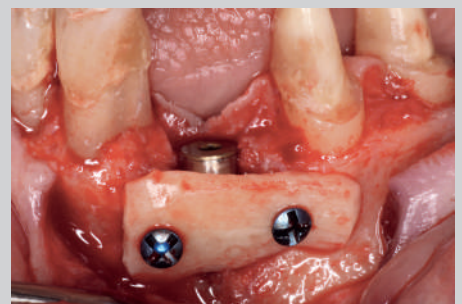
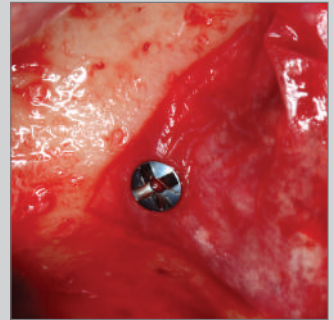
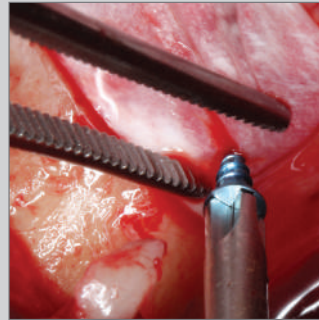
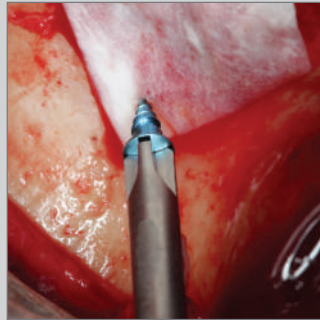
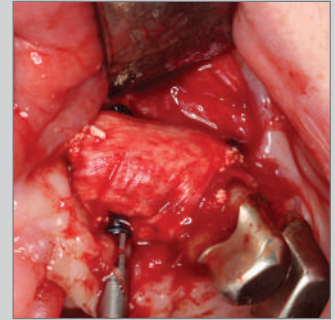
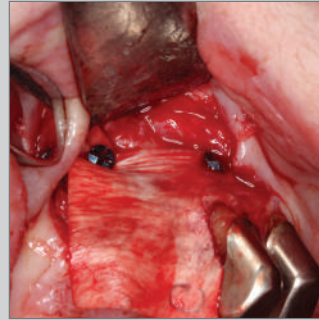
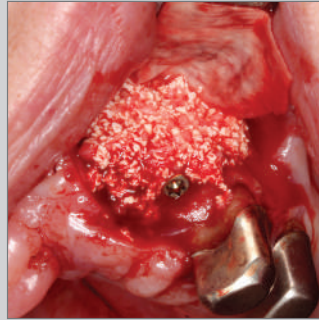
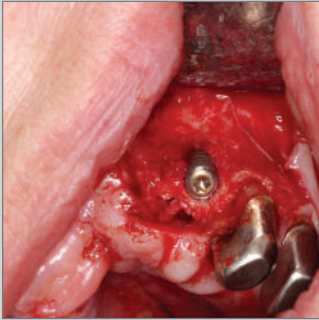

Photo: Dr. Stephan Beuer, M. Sc.



## T-FIX MEMBRANE SCREW

- titanium
- conical thread
- length: 4 mm
- self-cutting/self-drilling, no pre-drilling
- perfect for applications in strong cortical bone
- for PTFE and titanium-reinforced membranes



∅ 1,5 mm, 10 pcs.

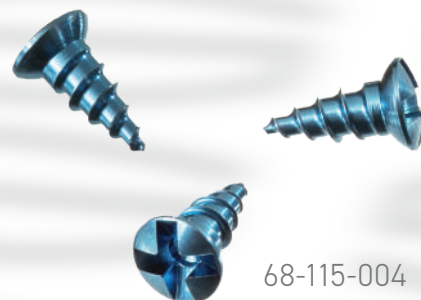

68-115-004

# UMBRELLA-TECHNIQUE BY DR. DR. SCHLEE

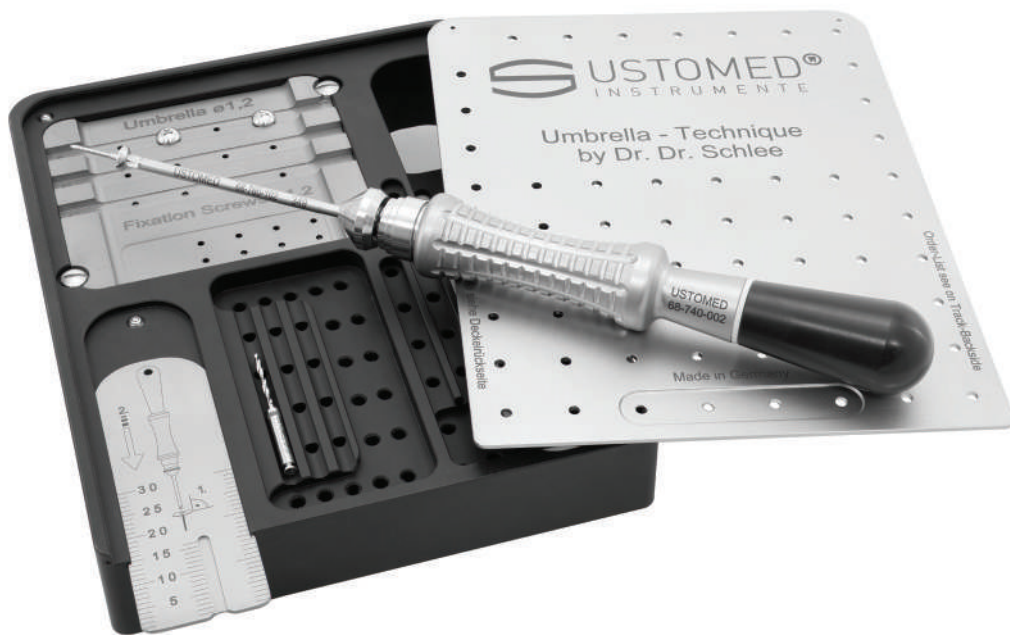

## IMPLANT-STEEL ALLOY

- diameter: 1,2 mm
- lengths: 8 mm / 11 mm / 13 mm
- screw head diameter: 5 mm
- no Osseointegration

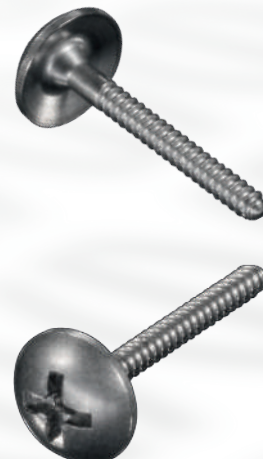

highly-magnified presentation

68-780-014

Umbrella-Technique-Set



CONTENT:

- 68-720-010 Box for Umbrella-Screws
- 68-740-002 Screwdriver, 11cm, Fig. 2
- 68-760-102 Blade, cross, self-retaining, 60mm length, for 68-740-002
- 68-510-014 Pilot drill, Ø 1, 0mm, 14mm
- \* 6x Umbrella Screw of choice

Umbrella Screw (packed individually)

- 68-112-208 S Steel, Ø 1, 2mm, 8mm length, cross
- 68-112-211 S Steel, Ø 1, 2mm, 11mm length, cross
- 68-112-213 S Steel, Ø 1, 2mm, 13mm length, cross

Accessories:

- 68-720-002 Box for Micro-Screws Ø 1,0/ 1,2/ 1,4mm
- 68-740-002 Screwdriver, 11cm, Fig. 2
- 68-760-106 Blade, cross, self-retaining, short, for Contra-Angle HP

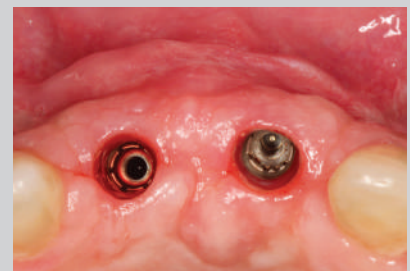
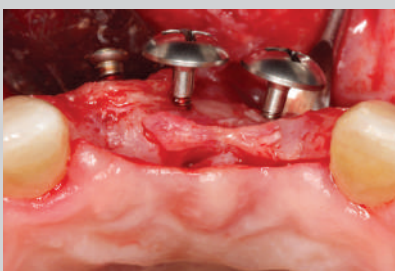
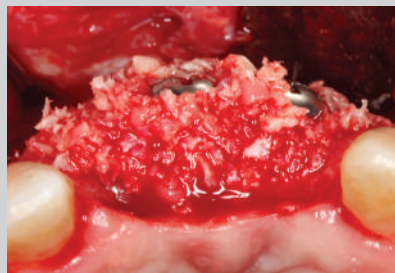

# 73 ORGANIZATION AND STORAGE







73-134-024

USTOMED, bur block, 12 x FG, 12 x RA



73-100-050

Needle and Drill sterilizing box, perforated, 50 x 25 x 4,5 mm

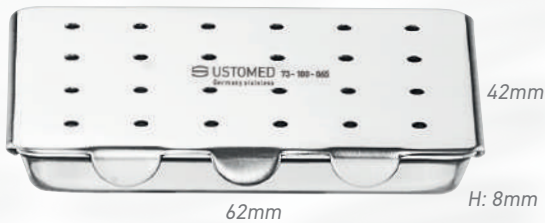

73-100-065

Needle and Drill sterilizing box, perforated, 65 x 42 x 8 mm



73-106-065

Sterilizing box, unperforated, 65 x 42 x 8 mm



73-120-065

Needle and Drill sterilizing box, Ø 65 mm



73-124-062

Insert only, for box 73-120-065

# 73

## Jars



**73-200-002**

Jar, Ø 50 mm, height 100 mm



**73-200-003**

Jar, Ø 50 mm, height 130 mm



**73-251-250**

Kidney bowl, 250 x 140 x 40 mm

1/2

**INFO**

User's favorite



**73-290-025**  
Metal-Bowl, 25 cc

**INFO**

Heavy built,  
for a safe stance



**73-295-000**  
Graft-Bowl



**73-292-050**  
Metal-Bowl, 50 cc,  
graduated inside



**73-294-125**  
Metal-Bowl, 125 cc



**73-294-050**  
Metal-Bowl, 50 cc

# 79 CLEANING AND CARE

## INFO

For maintenance of instruments **prior** to sterilization, for all instruments with joints, scissors, forceps, etc.



79-140-050

SURGI-STAIN, corrosion-ex,  
Passivation Bath



79-130-040

USTOMED, oil spray, 500 ml,  
biocompatible, sterilizable

# 80

## EXTRACTING FORCEPS ENGLISH PATTERN





**80-001-000 HP**

Figure 1, upper incisors and canines, wide



**80-002-000 HP**

Figure 2, upper incisors and canines



**80-334-000 HP**

Figure 34, upper incisors and canines, deep-gripping

**INFO**

Reaches under the gingival margin



1/1

80-007-000 HP

Figure 7, upper premolars



1/1

80-335-000 HP

Figure 35, upper premolars, deep-gripping

**INFO**  
Reaches under the  
gingival margin

# 80

English Pattern, non-slip



**80-017-000 HP**

Figure 17, upper molars, right



**80-018-000 HP**

Figure 18, upper molars, left





1/1

80-067-000 HP

Figure 67, upper third molars



1/1

80-067-001 HP

Figure 67A, upper third molars, narrow

# 80

## English Pattern, non-slip



1/1

**80-051-000 HP**

Figure 51, upper roots



1/1

**80-051-001 HP**

Figure 51A, upper roots,  
narrow



1/1

**80-051-012 HP**

Figure 51L, upper roots,  
longer

# WITZEL



**INFO**  
The 45° angle allows these forceps to be used for upper and lower roots



80-355-000

1/1

Special Forceps, very fine, upper and lower roots

80-397-000 HP

1/1

Figure 97, upper root fragments

## STIEGLITZ



1/1

**80-555-000**

Special Forceps,  
very fine for roots



1/1

**17-717-135**

Splinter forceps, angled,  
diamond-coated



1/1

**80-597-000**

Figure 97, upper  
root fragments



**INFO**  
Reaches under the gingival margin



1/1



1/1



1/1

80-013-000 HP

Figure 13, lower incisors

80-013-001 HP

Figure 13A, premolars, narrow

80-336-000 HP

Figure 36, lower incisors and premolars, deep-gripping

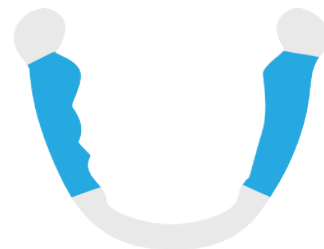

1/1

80-022-000 HP

Figure 22, lower molars

**INFO**  
For children



1/1

80-022-019

Figure 22S, lower molars



80-086-001

Figure 86A, Cowhorn, lower molars



English Pattern, non-slip

80



1/1

**80-079-000 HP**

Figure 79, lower third molars, with tips



1/1

**80-079-001 HP**

Figure 79A, lower third molars



1/1

**80-300-000**

Special Forceps, upper and lower wisdom teeth

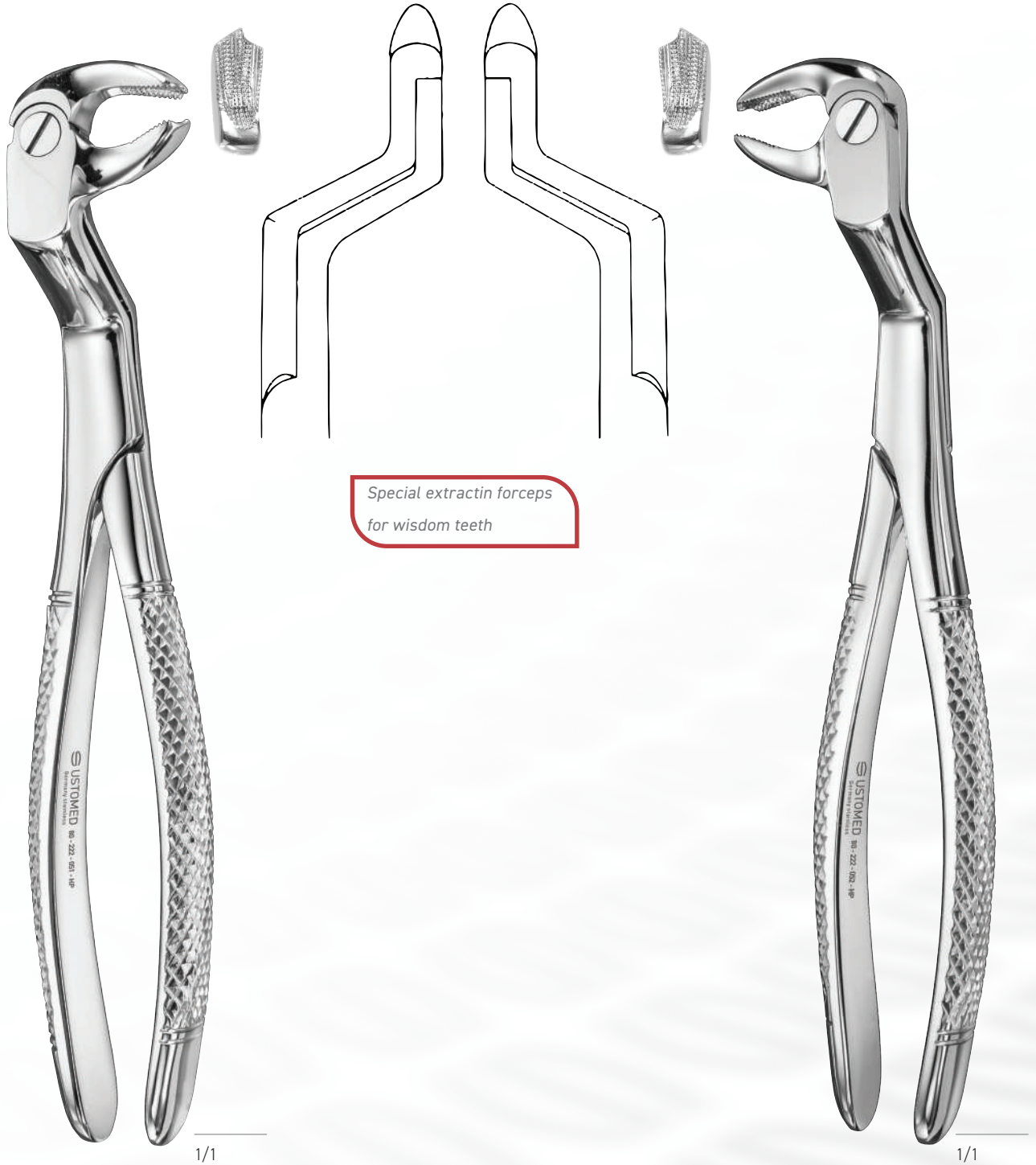

80-222-051 HP

Figure L, lower wisdom teeth, left

80-222-052

Figure R, lower wisdom teeth, right





80-346-012 HP

Figure 46L,  
lower roots

80-033-000 HP

Figure 33,  
lower roots

80-033-001 HP

Figure 33A, lower  
roots, narrow

80-033-012 HP

Figure 33L, lower  
roots, longer

## STIEGLITZ



1/1

17-717-135

Splinter forceps, angled,  
diamond-coated



1/1

80-546-012

Figure 46L,  
lower roots



1/1

80-555-000

Special Forceps,  
very fine for roots



KLEIN

Extracting Forceps for Children

80



80-860-000  
upper incisors

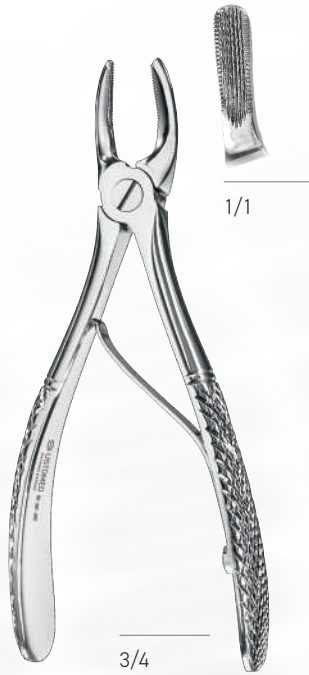

80-861-000  
upper premolars



80-865-000  
upper molars



80-863-000  
upper roots



80-867-000  
lower incisors



80-869-000  
lower molars

**80-860-006**

complete Set, consisting  
of 4 forceps upper jaw  
and 2 forceps lower jaw

80-000-010

Basic Extraction Forceps Set



80-002-000 HP



80-007-000 HP



80-017-000 HP



80-018-000 HP



80-067-000 HP



80-051-000 HP



80-013-001 HP



80-022-000 HP



80-079-001 HP



80-346-012 HP

# 81 EXTRACTING FORCEPS WITH ANATOMICALLY SHAPED HANDLE



# 81

## Anatomical Grip, non-slip



81-002-000 HP

Figure 2, upper incisors and canines



### INFO

Reaches under the gingival margin

81-334-000 HP

Figure 34, upper incisors and canines, deep-gripping



81-007-000 HP

Figure 7, upper premolars



**INFO**

Reaches under the gingival margin

81-335-000 HP

Figure 35, upper premolars, deep-gripping

# 81

## Anatomical Grip, non-slip



81-017-000 HP

Figure 17, upper molars, right



81-018-000 HP

Figure 18, upper molars, left





1/1

### 81-067-000 HP

Figure 67, upper third molars, bayonet



1/1

### 81-051-000 HP

Figure 51, upper roots, bayonet



1/1

### 81-051-001 HP

Figure 51A, upper roots, narrow, bayonet

# 81

## Anatomical Grip, non-slip



81-013-001 HP

Figure 13A, lower incisors, narrow



81-013-000 HP

Figure 13, premolars



81-336-000 HP

Figure 36, lower incisors and premolars, deep-gripping

### INFO

Reaches under the gingival margin

## Anatomical Grip, non-slip



**81-022-000 HP**

Figure 22, lower molars



**81-086-001**

Figure 86A, Cowhorn,  
lower molars



**81-079-000 HP**

Figure 79, lower third  
molars, with tips

# 83 ROOT ELEVATORS



BEIN



1/1



1/1



1/1



1/1

83-100-002  
straight, 2 mm

83-100-003  
straight, 3 mm

83-100-004  
straight, 4 mm

83-100-005  
straight, 5 mm

# 83

## Root Elevators

### BEIN

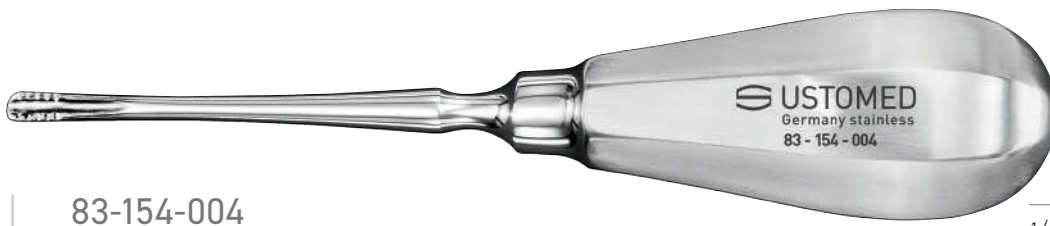

83-154-004

serrated, 4 mm

1/1



1/1

83-111-025

curved backwards,  
2,5 mm



1/1

83-111-035

curved backwards,  
3,5 mm



1/1

83-111-045

curved backwards,  
4,5 mm



1/1

83-117-035

modified, bayonet,  
3,5 mm

USTO-LUX



1/1

83-120-003

straight, 3 mm, delicate



1/1

83-120-004

straight, 4 mm, delicate



1/1

83-120-005

straight, 5 mm, delicate

### USTO-LUX



**83-121-003**

curved, 3 mm, delicate



**83-121-004**

curved, 4 mm, delicate



**83-121-005**

curved, 5 mm, delicate



FLOHR

CRYER



1/1



1/1



1/1



1/1

83-151-003  
angled, size 3

83-151-004  
angled, size 4

83-151-007  
angled, size 7

83-151-008  
angled, size 8

### HEIDBRINK



1/1

83-231-009  
angled, size 9



1/1

83-230-008  
straight, size 8



1/1

83-231-010  
angled, size 10

CRYER

FLOHR



1/1

83-427-001  
angled, right



1/1

83-427-002  
angled, left



1/1

83-445-028  
size 28, angled



1/1

83-445-027  
size 27, angled

# 83

## Root Elevators

### WINTER



**83-741-006**  
size 12R, cross handle

### BARRY



**83-761-321**  
size 321, cross handle



**83-741-005**  
size 12L, cross handle



**83-761-320**  
size 320, cross handle

MOD. WIEN

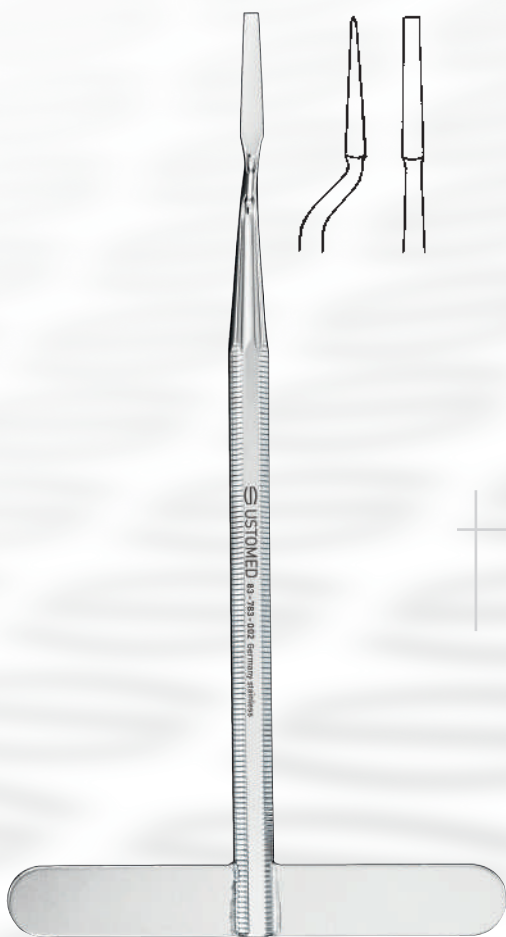

**83-783-003**

rotating elevator, 3 mm,  
bayonet



**83-783-004**

rotating elevator, 4 mm,  
bayonet

**83-783-002**

rotating elevator, 2 mm,  
bayonet

# 83

## Fragment Ejectors



1/1



1/1



1/1

## STIEGLITZ



1/1

83-871-001

size 1,  
double-ended

83-871-002

size 2,  
double-ended

83-871-003

size 3,  
double-ended

17-717-135

Splinter forceps, angled,  
diamond-coated



1/1

**83-904-000**

size 0, straight,  
hollow handle

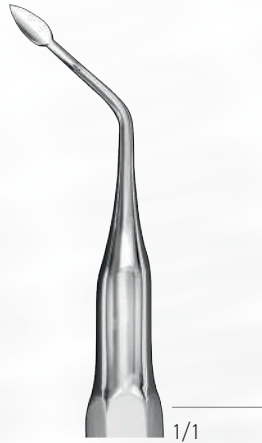

1/1

**83-905-002**

size 2, angled,  
hollow handle



1/1

**83-905-001**

size 1, angled,  
hollow handle



1/1

**83-899-002**

size 2, angled,  
octagonal handle



1/1

**83-899-001**

size 1, angled,  
octagonal handle



1/1

**83-898-000**

size 0, straight,  
octagonal handle

# 84 BASIC INSTRUMENTS, MOUTH MIRRORS AND SYRINGES





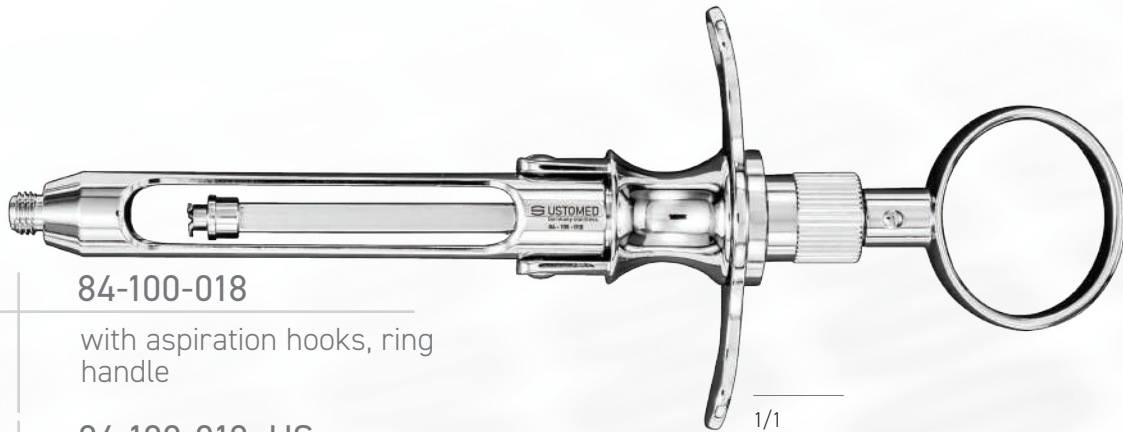

84-100-018

with aspiration hooks, ring handle

84-100-018\_US

US-Standard Cartridge version

1/1

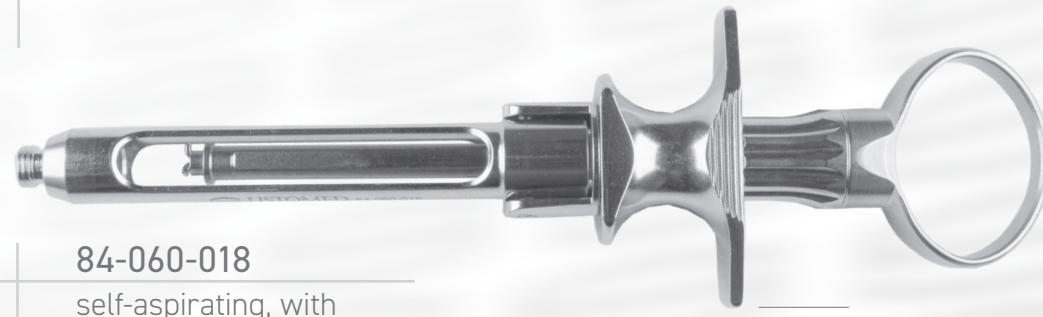

84-060-018

self-aspirating, with aspiration hooks, ring handle, stainless

1/1

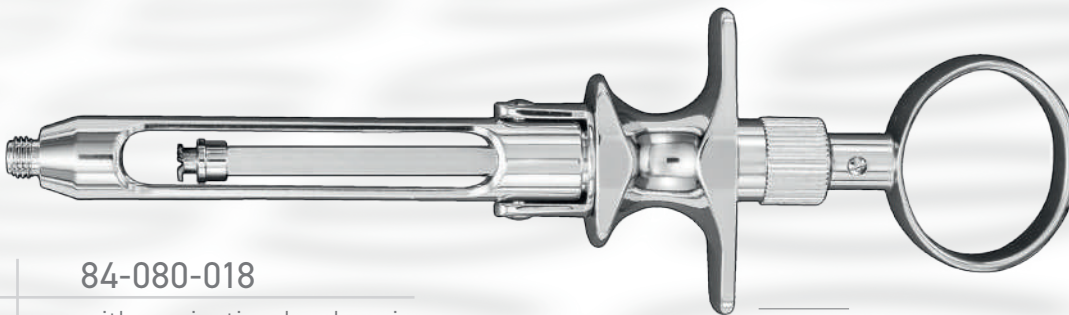

84-080-018

with aspiration hooks, ring handle, compact

1/1



84-116-018

Exchangeable Cartridge holder, aspiration hooks, ring handle

1/1

# 84

## Intra-ligamental Cartridge Syringes

### PAROJECT (RØNVIG)



84-149-000

Syringe with automated-pressure regulation  
for intra-ligamental use



1/1

### 84-126-050

Spare attachment for  
84-110-018 / 84-112-018

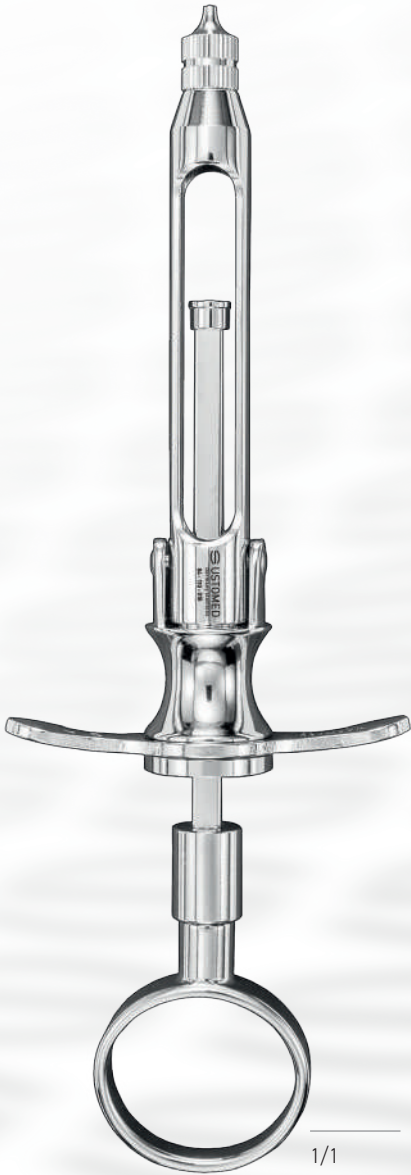

1/1

### 84-110-018

Self-aspirating, ring handle



1/1

### 84-135-000

Ointment Cannulas,  
pack of 10



1/1

### 84-161-001

Spare cannula, Ø 2,  
0 mm, Luer-Lock

# 84

## Mouth Mirror Handles



1/1



1/1



1/1



1/1



1/1

**84-218-000**

anatomical  
shape

**84-220-000**

solid,  
octagonal  
shape

**84-225-000P0**

peek handle

**84-225-000POT3**

peek handle with  
metal rings

**84-224-000**

hexagonal  
shape,  
stainless-  
steel

**86-080-000**

Anatomical  
USTOMED handle,  
for probes and  
mirrors



	3 20 mm	4 22 mm	5 24 mm
plane		84-253-004	84-253-005
high-reflection (approx. 20% brighter)		84-265-004	84-265-005
plane, Rhodium (no double pictures)	84-273-003	<b>84-273-004</b>	84-273-005

**INFO**  
User's choice

**INFO**

In contrast to conventional mirrors, Rhodium front-surface mirrors have the reflecting metal coating applied to the surface of the mirror plate resulting in a **sharply** defined **refraction-free** image.

**84-224-004**

Combined mirror/  
cheek retractor,  
plane, Size 4

# 84

## Root Resection Mirrors



1/1

**84-285-003POT3**

plane, Rhodium,  
Ø 3 mm



1/1

**84-285-005POT3**

plane, Rhodium,  
Ø 5 mm



1/1

**84-285-062POT3**

plane, Rhodium,  
6x3 mm



**84-990-000**

Napkin holder



1/2

**84-295-170**

Mirror for buccal site



1/2

**84-292-210**

Mirror for lingual site

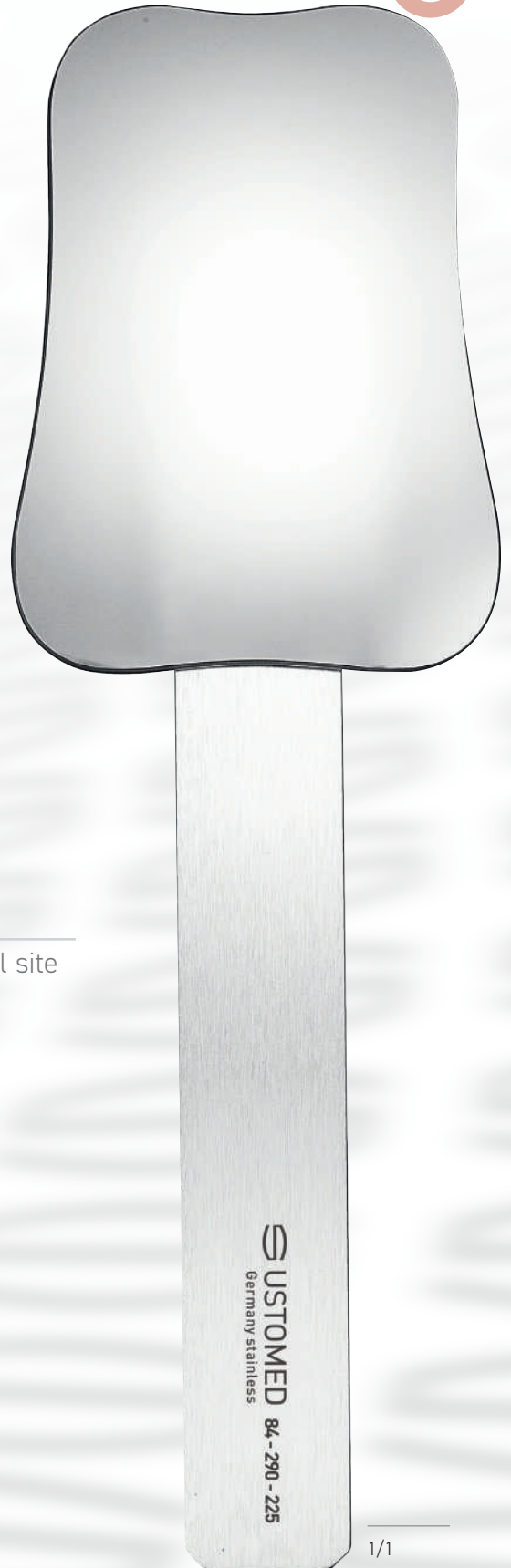

1/1

**84-290-225**

Mirror for occlusal site



**84-296-300**

Mirror Set (3 pcs.)

# 85

# PERIODONTICS





CUMINE



85-071-001  
Size 1



85-071-002  
Size 2



85-071-003  
Size 3



85-197-000  
Rheinwald lifter

# 85

## Excavators

WHITE



**85-321-017**

Size 17,  
double-ended

**85-321-017P0**

Size 17,  
double-ended,  
Peek Griff



**85-321-018**

Size 18,  
double-ended

**85-321-018P0**

Size 18,  
double-ended,  
Peek Griff



**85-327-128**

Size 127/128,  
double-ended

**85-327-128P0**

Size 127/128,  
double-ended,  
Peek Griff

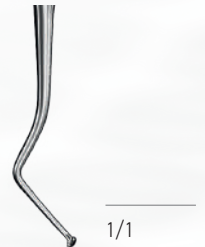

**85-327-130**

Size 129/130,  
double-ended

**85-327-130P0**

Size 129/130,  
double-ended,  
Peek Griff

**85-321-005**

Size 5, double-ended

**85-321-005P0**

Size 5, double-ended,  
peek handle

**85-327-126**

Size 125/126, double-ended

**85-327-126P0**

Size 125/126, double-ended,  
peek handle

## UNIVERSITY NORTH CAROLINA

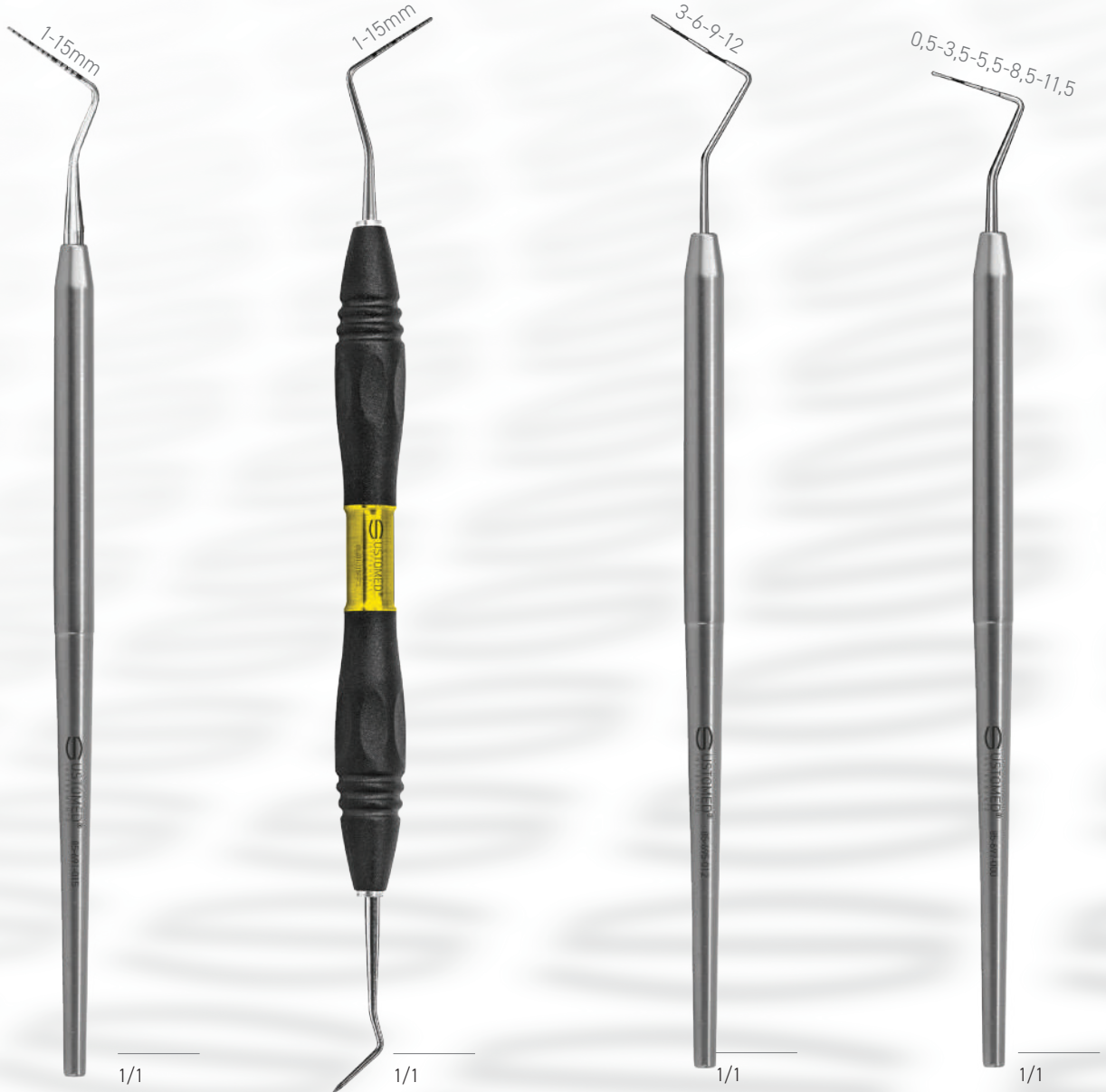

**85-691-015**

CP15

**85-691-015 P0**

CP15, peek handle

**85-691-115P0T3**

CP15 double-ended  
with Probe

**85-695-012**

CP 12, colour  
marking

**85-695-012P0**

CP 12, colour  
marking, peek  
handle

**85-697-000**

PSI/WHO,  
colour marking

**85-697-000P0**

PSI/WHO, colour  
marking, peek  
handle

# 85

## Periodontal Probes

### NABERS

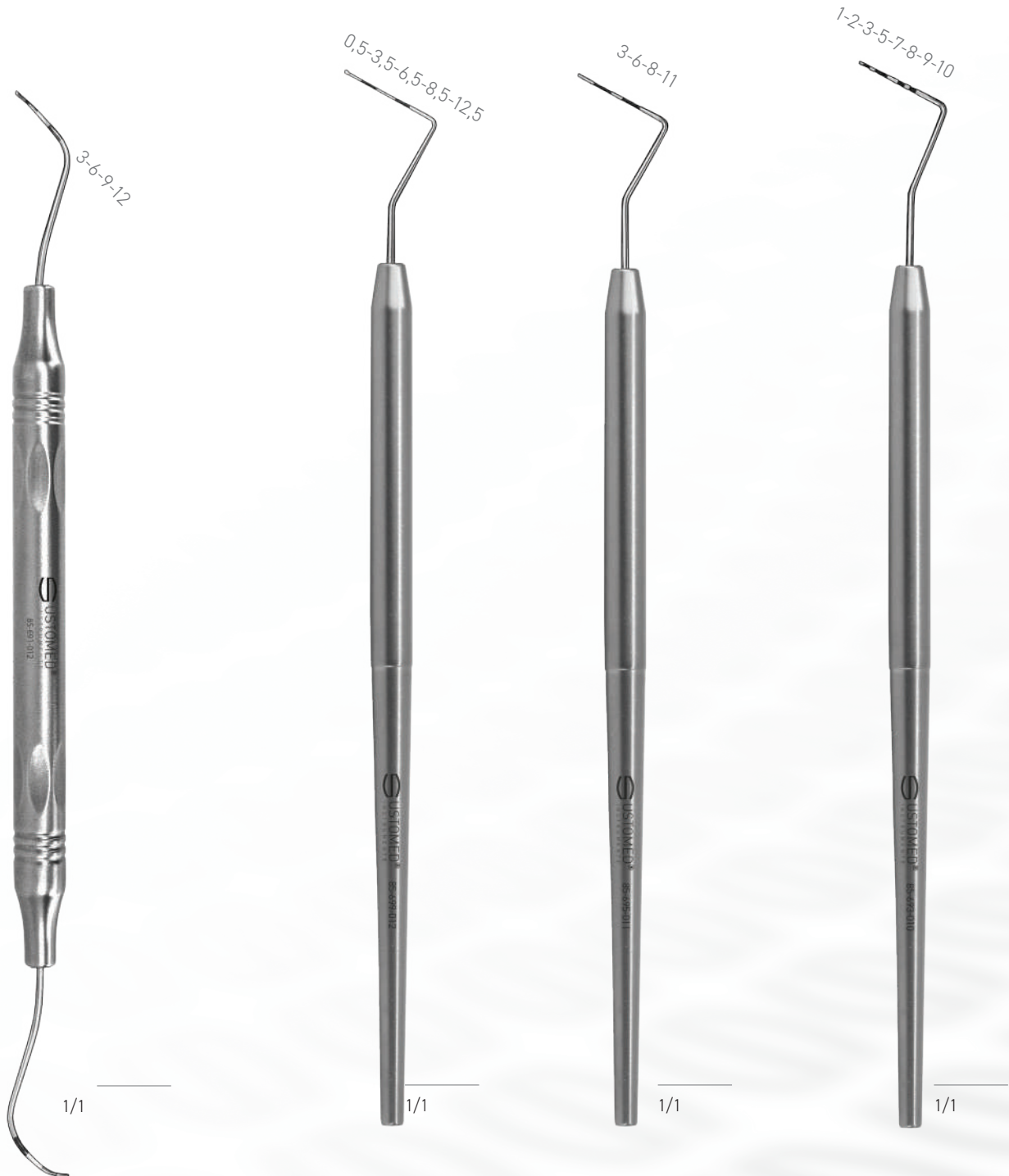

**85-691-012**

Q2N, probe,  
colour marking

**85-699-012**

CP12 modified,  
colour marking,  
with tall tip

**85-695-011**

CP 11, colour  
marking

**85-693-010**

CP 10, colour  
marking

**INFO**  
User's choice



**85-745-023**

M 23, double-ended, universal



**85-757-204**

204 SD, double-ended



**85-735-023**

T2/T3, double-ended



**85-749-067**

H6/H7, slight angulation, double-ended



**85-751-067**

H6/H7 modified, strong angulation, double-ended



**85-741-023**

CI 2/3, double-ended



**85-755-204**

204 S, double-ended



1/1

**85-779-056POT3**  
Curette, 5/6



1/1

**85-719-067POT6**  
Scaler, H6/H7



1/1

**85-729-204POT5**  
Scaler, 204 S

### GRACEY



1/1

**85-779-078POT2**  
Curette, 7/8



1/1

**85-779-112POT4**  
Curette, 11/12

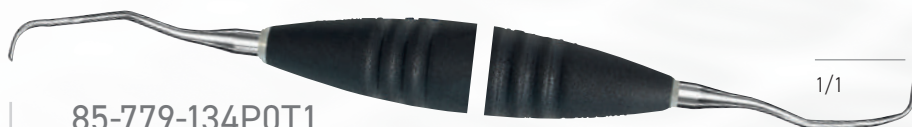

1/1

**85-779-134POT1**  
Curette, 13/14

**INFO**

Also available as  
Perio-Set



# GRACEY (ONE SIDED SHARP)



**85-781-034**  
3/4, double-ended

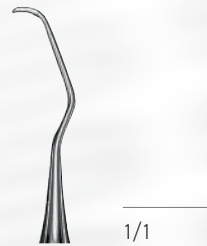

**85-781-056**  
5/6, double-ended

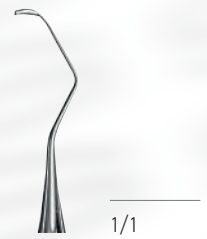

**85-781-078**  
7/8, double-ended

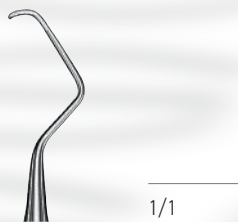

**85-781-012**  
1/2, double-ended

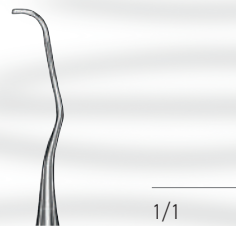

**85-781-091**  
9/10, double-ended



**85-781-112**  
11/12, double-ended

**85-781-134**  
13/14, double-ended

# 85

## Periodontal Curettes

### COLUMBIA



85-787-004

Curette, 4L/4R,  
double-ended

### MC CALL



85-789-178

Curette, universal, 17/18,  
double-ended

### LANGER



85-795-056

Curette, 5/6, titanium,  
double-ended, both-sided  
sharp

#### INFO

Titanium tips for  
cleaning of implant  
surfaces



USTO-SOFT-GRIFF USTOMED

ZUCHELLI



**INFO**  
*black coated tips, allow better visuability under gingiva*



85-814-175P0T3  
 Mod. Z, peek handle

85-812-175P0T3  
 Mod. W, peek handle

85-812-175  
 Mod. W

### USTO-SOFT-GRIP

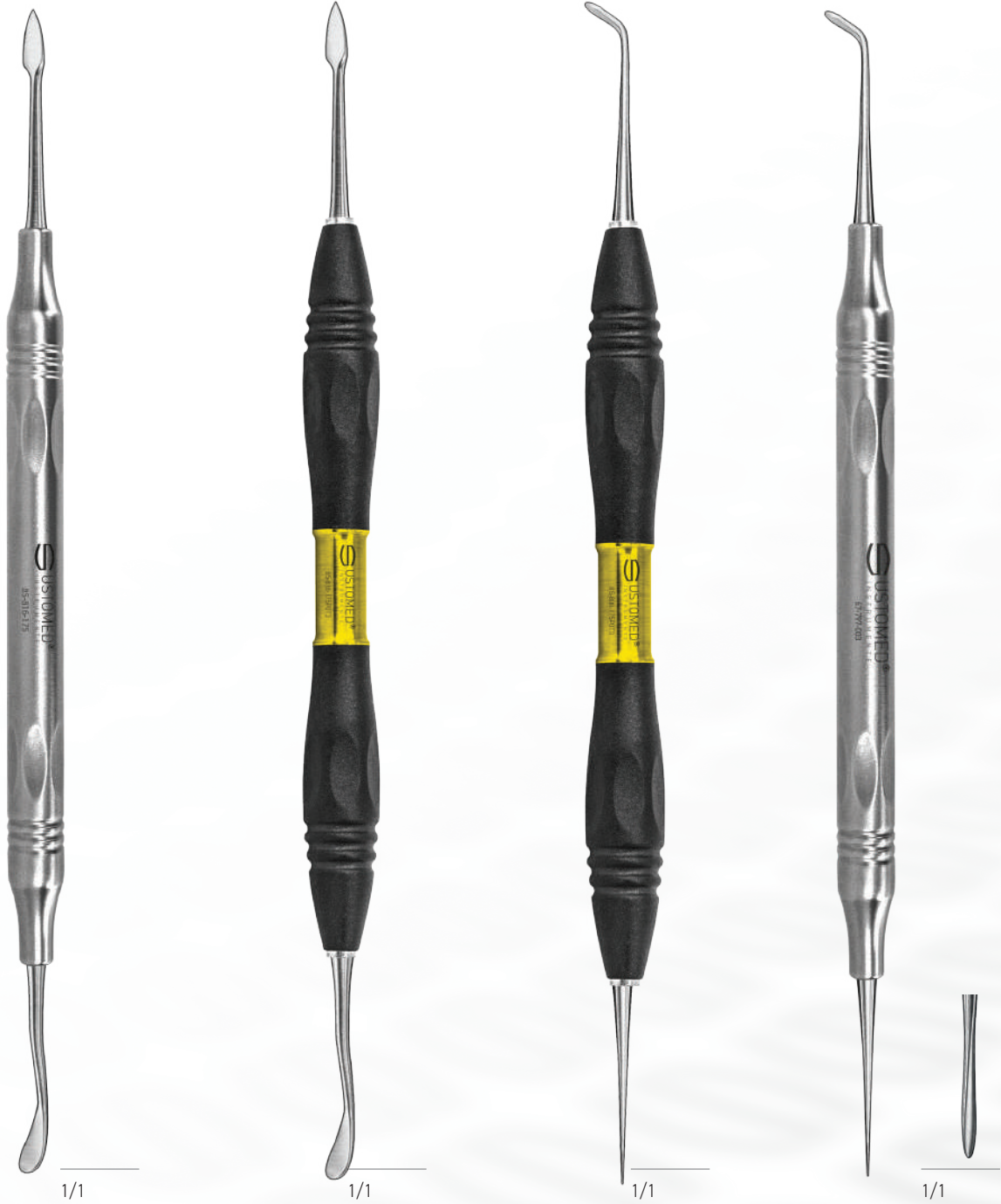

**85-816-175**

Mod. B, 17,5 cm

**85-816-175POT3**

Mod. B, 17,5 cm,  
peek handle

**85-808-175POT3**

Mod. W, 17,5 cm,  
peek handle

**85-808-175**

Mod. W, 17,5 cm

## KASAJ

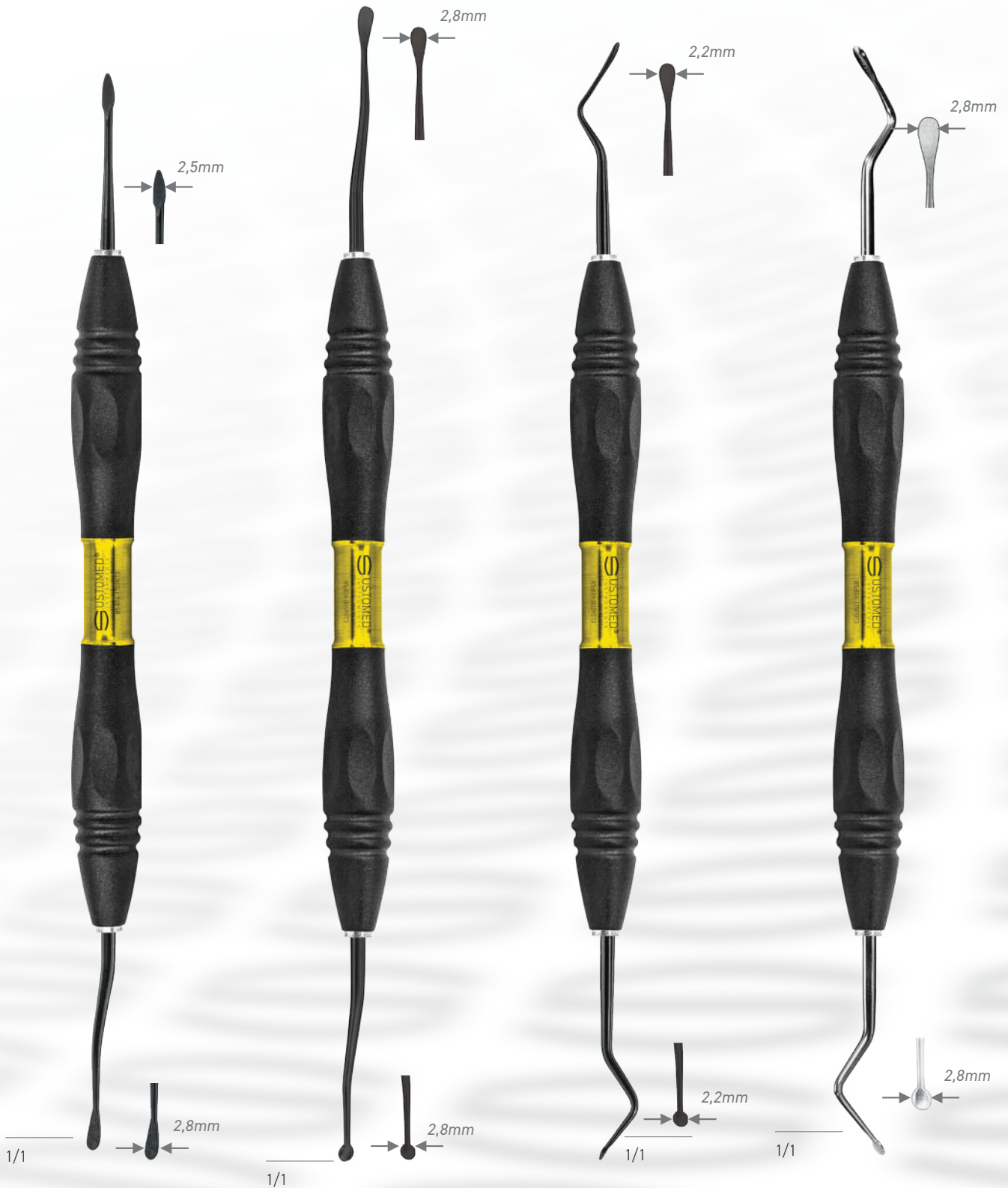

85-816-170 P0T3

Mod. B, micro

85-818-001P0T3

Tunnelling knife,  
micro, 20cm,  
posterior, peek  
handle

85-818-002P0T3

Tunnelling knife,  
micro, 19cm,  
anterior, peek handle

85-818-175 P0T3

Tunneling knife,  
19 cm, anterior,  
peek handle

# 85

## ORBAN



1/1

**85-831-012P0T3**

Gingivectomy knife,  
Or 1/Or 2, peek  
handle



1/1

**85-825-156P0T3**

Gingivectomy knife, double-ended,  
peek handle

# 86 HAND INSTRUMENTS



# 86

## Probes and Explorers, single-ended

ROUND HANDLE



**86-153-001**

Size 1

**86-153-001P0**

Size 1, peek handle

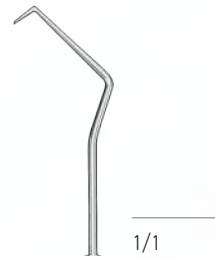

**86-153-017**

Size 17

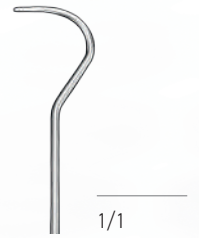

**86-153-044**

Size 44



**86-157-001**

Size 1,  
extra fine



**86-157-017**

Size 17,  
extra fine

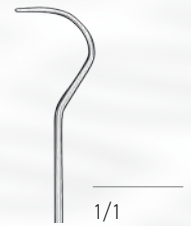

**86-157-044**

Size 44,  
extra fine



# 86

## Probes and Explorers, double-ended



**86-213-002**

Furcation Probe,  
unscaled



**86-223-003**

Size 3



**86-211-002**

Probe, extremely  
fine points





**INFO**  
User's choice

86-350-001  
Size 1

86-350-002  
Size 2

# 86

## Filling Instruments

Plugger, double-ended, ball

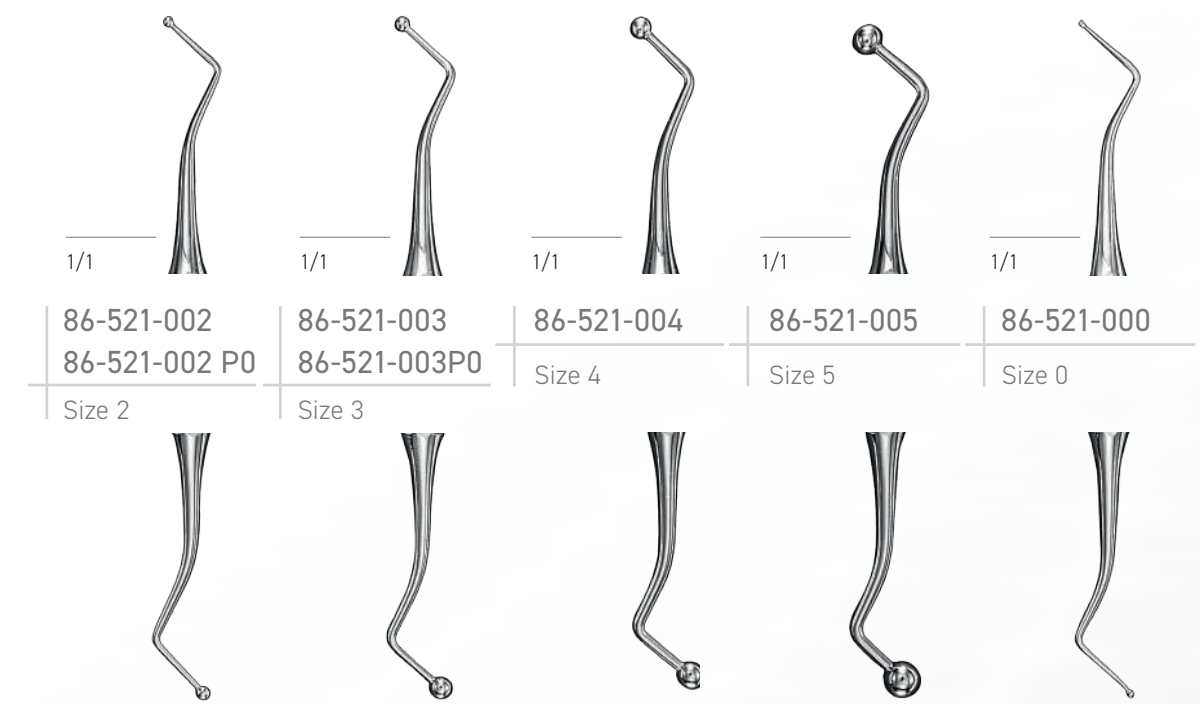

**86-521-001**

Size 1

**86-521-001P0**

Size 1, Peek Griff

# HEIDEMANN

flexible/semi-sharp



**86-721-001P0**

Size 1, peek handle

**86-721-001**

Size 1

**86-721-002P0**

Size 2, peek handle

**86-721-002**

Size 2

**86-721-003P0**

Size 3, peek handle

**86-721-003**

Size 3

# 86

## Filling Instruments

Spatule (rigid/blunt), double-ended



**86-551-000P0**

Size 0, peek handle

**86-551-000**

Size 0

**86-551-001P0**

Size 1, peek handle

**86-551-001**

Size 1

**86-521-014**

Size 14

**86-521-015**

Size 15

Plugger (pear-shaped), double-ended



1/1

86-521-017

Size 17



1/1

86-521-019

Size 19

Plugger (plain), double-ended



1/1

86-521-035

Size 35



1/1

86-521-036

Size 36



1/1

86-521-037

Size 37

Planisher, double-ended



1/1

86-521-061

Size 61, small



1/1

86-521-062

Size 62, medium



1/1

86-521-063

Size 63, large



1/1

86-521-018

Size 18

# 86

## Composite Instruments



86-589-003 POT3  
3TN

# 87

# PROSTHETICS



# 87

## Retrograde Filling Instruments

### R(H)EINSTOPFER

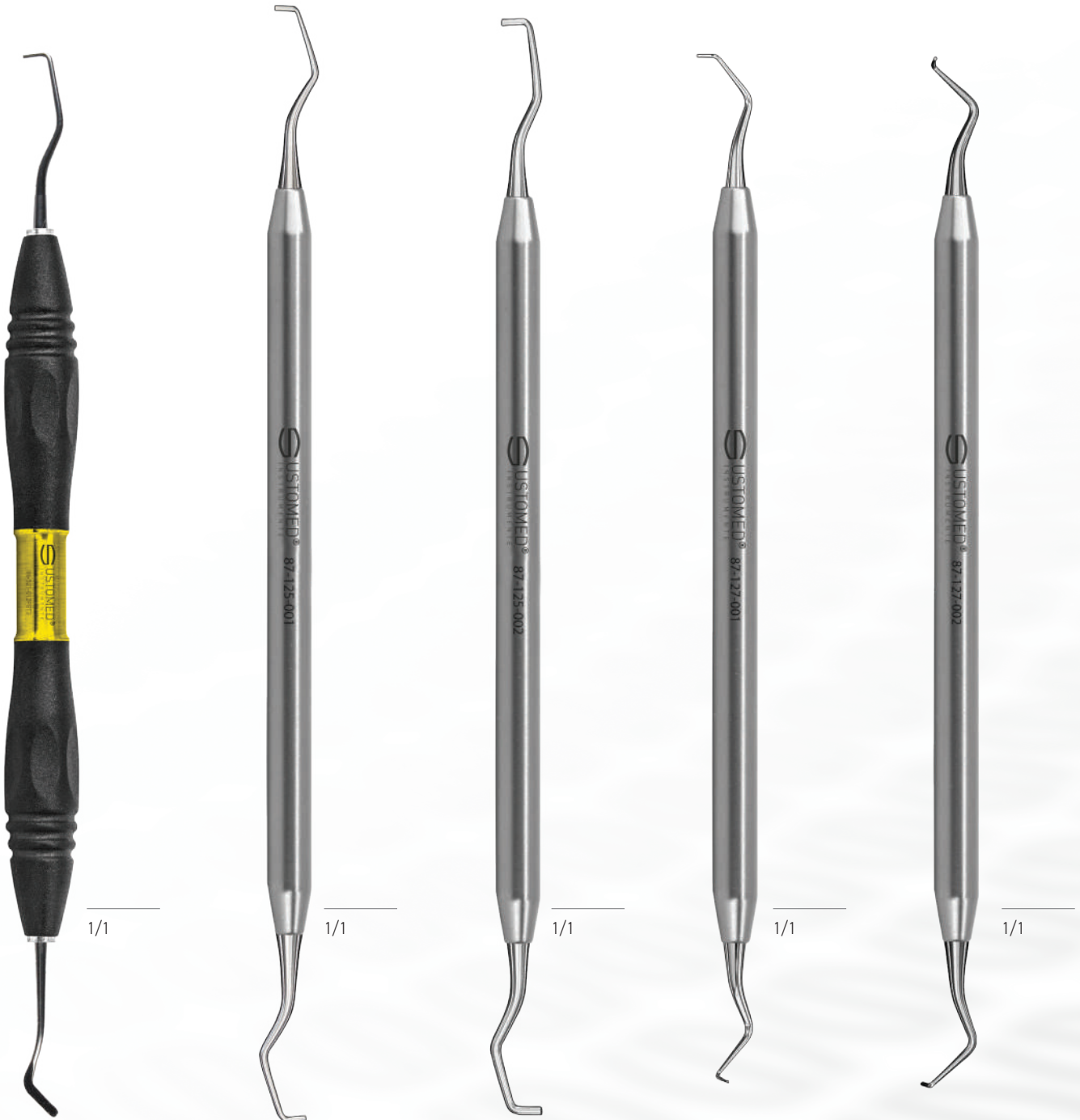

86-521-012P0T3

Size 2 retrograde and Size 1 regular, peek handle

87-125-001

Size 1, double-ended

87-125-002

Size 2, double-ended

87-127-001

Mod. K, Size 1

87-127-002

Mod. K, Size 2



## FAHNENSTOCK



1/1

Wax Knife

**87-290-130**

13 cm

**87-290-175**

17,5 cm

## AINSWORTH



1/1

**87-420-000**

Rubberdam Punch, 17 cm



**87-573-000**

UNIVERSAL, crown spreader



**87-570-000**

Crown Spreader, straight

TOFFLEMIRE



87-344-001

1/1

Matrix Band, Size 1, 12 pcs



87-344-002

1/1

Matrix Band, Size 2, 12 pcs



87-344-003

1/1

Matrix Band, Size 3, 12 pcs

TOFFLEMIRE-  
UNIVERSAL



1/1

87-340-000

Matrix Retainer

TOFFLEMIRE-JUNIOR



1/1

87-340-001

Matrix Retainer

TOFFLEMIRE-SENIOR



1/1

87-340-002

Matrix Retainer

# 87

## Crown Remover and Spreader

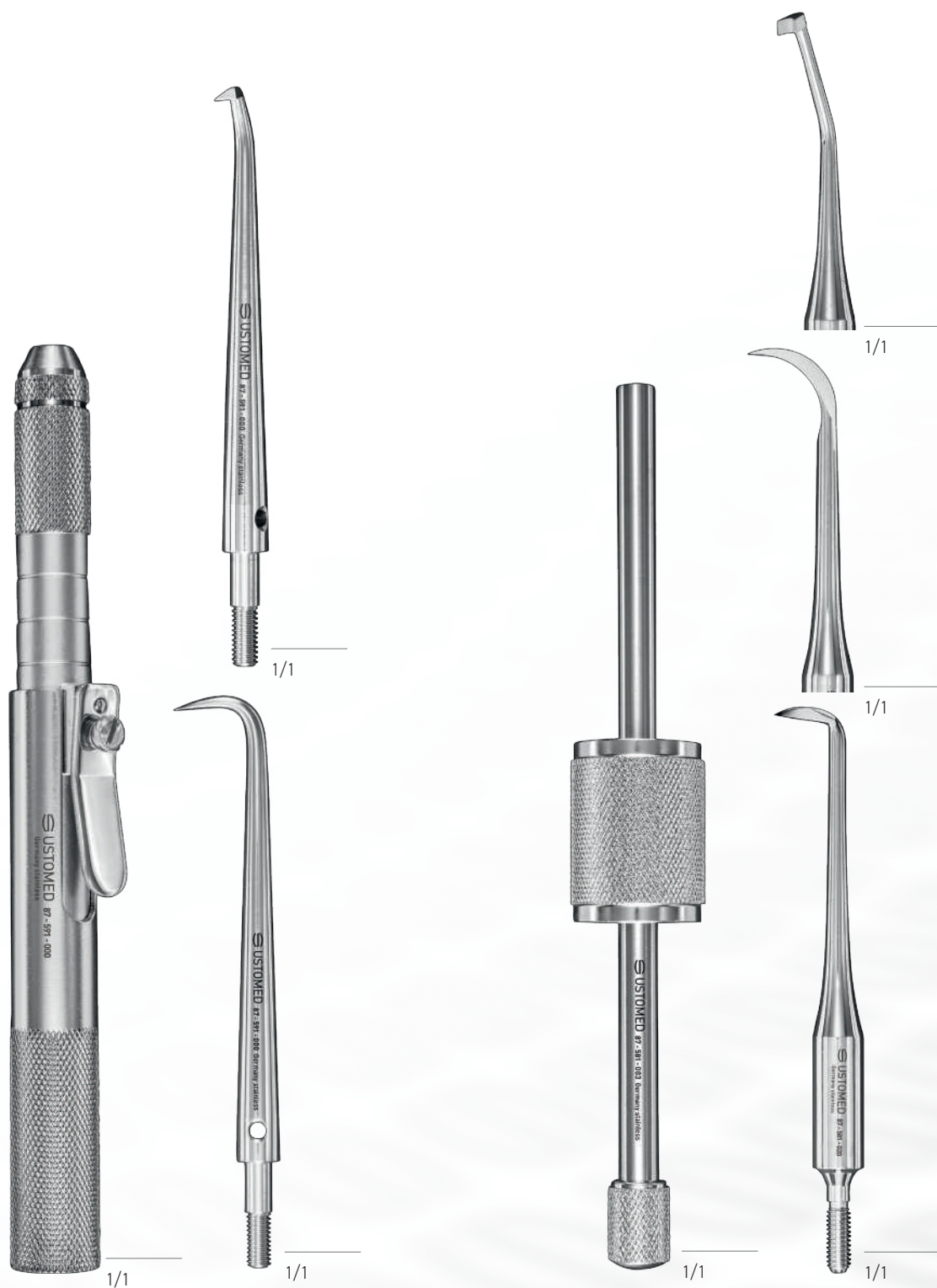

**87-591-000**

Crown/Bridge remover, semi-automatic,  
incl. 2 Attachments

**87-581-003**

Crown Remover, incl. 3 Attachments

# 88 IMPRESSION TRAYS



Upper Jaw, perforated



Lower Jaw, perforated



<b>88-100-000</b>	<b>88-100-003</b>
Size 0	Size 3
<b>88-100-001</b>	<b>88-100-004</b>
Size 1	Size 4
<b>88-100-002</b>	
Size 2	

<b>88-116-000</b>	<b>88-116-003</b>
Size 0	Size 3
<b>88-116-001</b>	<b>88-116-004</b>
Size 1	Size 4
<b>88-116-002</b>	
Size 2	

Upper Jaw, rim-type



88-300-001	88-300-004
Size S	Size XL
88-300-002	88-300-005
Size M	Size XXL
88-300-003	
Size L	

Lower Jaw, rim-type



88-310-001	88-310-004
Size S	Size XL
88-310-002	88-310-005
Size M	Size XXL
88-310-003	
Size L	

SCHEUFELE



88-240-001  
Occlusion Tray, small



88-240-002  
Occlusion Tray, large

89

# PROSTHETICS







1/1

**89-115-140**

CROWN TRACTOR,  
complete with 10 pcs.  
Spare jaws and 10 g  
adhesive powder



1/1

**89-120-140**

FURRER,  
pliers, remov.  
provis.a.copper ring



**89-115-020**

Exch. spare jaws,  
synthetic, pack.  
20ea.



**89-115-010**

Phiaal, cont. 10 g  
adhesive powder



89-140-010

DEGIDI, Cono Grip,  
silicone pads,

## DEGIDI



89-140-011

DEGIDI Cono Grip,  
upper jaw, delicate



89-140-023

DEGIDI Cono Grip,  
lower jaw



1/1

89-179-002

Diamond inserts,  
only, 2 ea. pack.



89-179-099

Allan key, only



89-179-125

BÖHM, telescope crown  
pliers, diamond tips, incl.  
Allen key and tips



**89-554-140**

cross-cut jaws



**89-370-115**

ADERER, wire and clasp  
bending pliers



**89-260-160**

UNIVERSAL, pin rough.,  
cutt.and bend.plier



89-752-130

Mixing bowl of soft silicone, Ø 13 cm



89-720-190

Plaster and laborat.spatula,  
elastic bla.

# 90 STORAGE, ORGANISATION AND STERILIZATION





**90-200-000**

Norm-Tray Cassette, Full-Size, unperforated



**90-204-000**

Norm-Tray Cassette, Full-Size, perforated bottom



**90-210-001**

Unperforated Lid, only



**90-218-001**

Perforated Bottom, only



**90-304-000**

Norm-Tray Cassette, Demi-Size, perforated bottom

**90-214-001**

Unperforated Bottom, only



**90-230-000**

Storing Frame, Y-type, Full-Size



**90-330-000**

Storing Frame, Y-type, Demi-Size

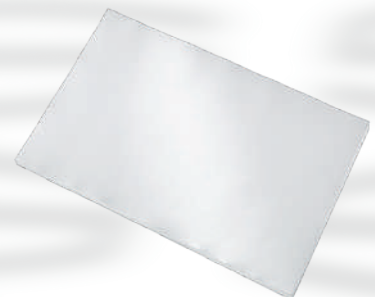

**90-126-100**

Paper Filters for Norm-Trays (250 pcs/pack)

# 90

## Organization

### INFO

Storing Trays for an optimal Organization of Hand Instruments during Cleaning, Sterilization and Storage. Advantage: Tips of instruments are being saved and it speeds up the processing.



90-340-004

Storing Tray, Quarter-Size, for 4 instruments (Mirror, Probe, Perio Probe, Tweezers)



90-340-005

Storing Tray, Quarter-Size, for 5 instruments



90-340-008

Storing Tray, Demi-Size, for 8 instruments

### INFO

Fits the Demi Container  
90-628-040

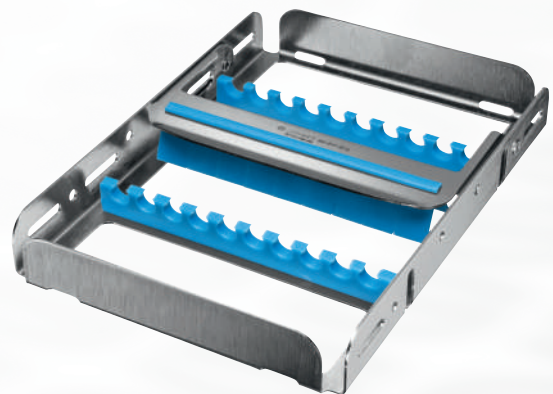

90-340-010

Storing Tray, Demi-Size, for 10 instruments

Additional colours:

Tray item number +	- 001	Blue	- 006	White
	- 002	Green	- 007	Orange
	- 003	Yellow	- 008	Purple
	- 004	Red		
	- 005	Black		



**INFO**

*For storage of Sterile Sets*



**90-620-040**

Sterilization Container, Full-Size, 4 cm  
315 x 190 x 40mm

**90-620-065**

Sterilization Container, Full-Size, 6,5 cm  
315 x 190 x 65mm



**90-618-100**

Sterilization Container, Full-Size, 10 cm  
315 x 190 x 100mm

**90-618-130**

Sterilization Container, Full-Size, 13 cm  
315 x 190 x 130mm

**INFO**

*Accessoires for Container  
on page 203!*

# 90

## Sterilization



### INFO

Sterilization Container with permanent filter!



### 90-626-040

Sterilization Container, Full-Size, Pasteurian Loops, 4 cm  
315 x 190 x 40mm

### 90-626-065

Sterilization Container, Full-Size, Pasteurian Loops, 6,5 cm  
315 x 190 x 65mm

### 90-628-040

Sterilization Container, Demi-Size, Pasteurian Loops, 4 cm  
195 x 145 x 40mm

### 90-628-065

Sterilization Container, Demi-Size, Pasteurian Loops, 6,5 cm  
195 x 145 x 65mm

### DENTAL STERILIZATION-CONTAINER SYSTEM WITH SAFETY-FILTER

Ustomed's answer to consistently increasing demands for risk minimization, environmental protection and handling comfort, is the newly-developed Easy-Stop System.

The filterless mechanism stops microorganisms even more effectively than conventional filter systems and can be re-used as often as you like. There is no need for consumable purchasing.

To open or close, one handling step is enough:

Simply, press the lid down, and turn!

### THE ADVANTAGES SPEAK FOR THEMSELVES:

- The unique lid is almost indestructible: It is precision-milled from a solid block of aluminum. That way, the lid stays in shape and can withstand the daily office routines.
- Dirt- and germ-repellent
- Fast and residue-free drying during steam-sterilization
- High quality material for triple safety: adhere-free, pore-free and corrosion-free

### INFO:

The two-piece aluminum insert in the lid serves as a germ barrier according to the principle of the „Pasteur Loops“. By forming a labyrinth of ring ribs, it therefore reliably separates microbes, germs and particles.

The meandering flow path achieves a decontamination rate of 99.997%





Ustomed  
Teflon-Filter

**90-643-001**

Teflon-Filter, for series  
90-620-xxx

**90-642-001**

Teflon-Filter, for series  
90-618-xxx

Marking Plates,  
including labeling

(max. 16 characters)



**90-650-000**

Red



**90-650-001**

Blue



**90-650-002**

Green



**90-650-003**

Yellow



**90-650-004**

Black



**90-650-005**

Silver



**90-650-007**

Purple



**90-650-008**

Orange



**90-665-100**

Sealing Plombs with  
indicator fields (100 pcs/  
pack)

or

**90-665-110**

Sealing Plombs  
(1000 pcs/pack)



**90-654-000**

Identification Label,  
HIBC, Data Matrix

or

**90-656-000**

Identification Label,  
HIBC, Code 128

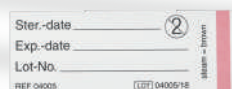

**90-662-100**

Indicator Labels  
(100 pcs/pack)

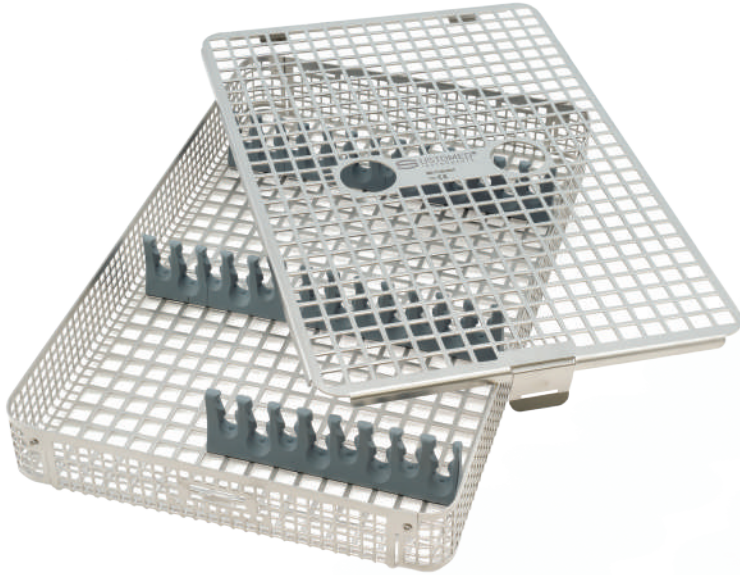

90-716-001

Wash Basket, Full-Size, MK 4, cross-wise racks

90-716-002

Wash Basket, Full-Size, MK 4, longitudinal racks

90-716-000

Wash Basket, Full-Size, MK 4

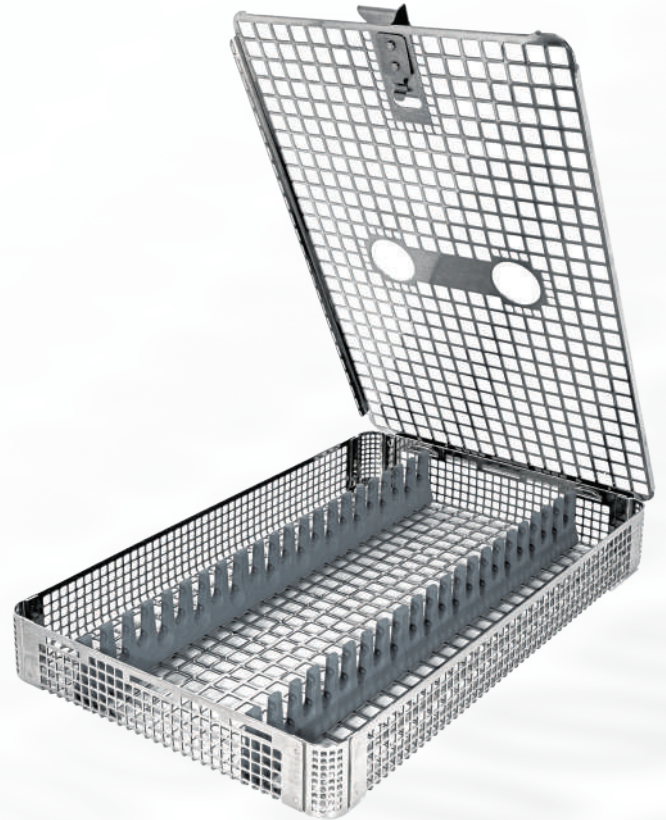

90-716-050

Wash Basket, Demi-Size, MK 4



90

# 91 INSTRUMENT SETS

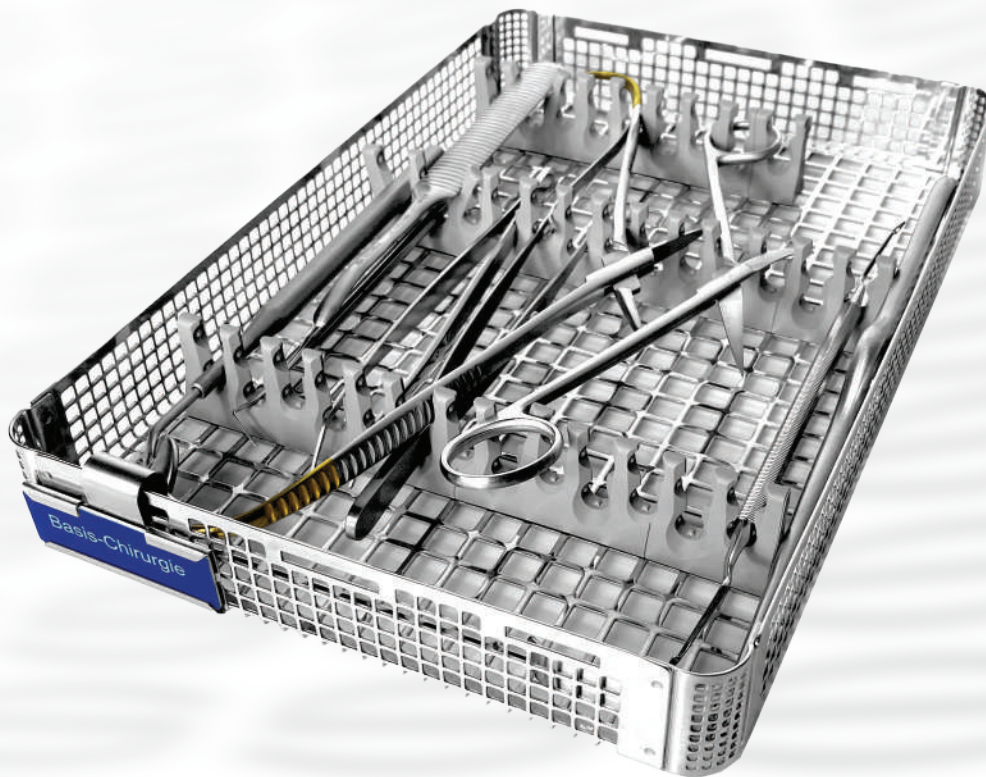

# 91

SET

## BASIC SURGICAL SET

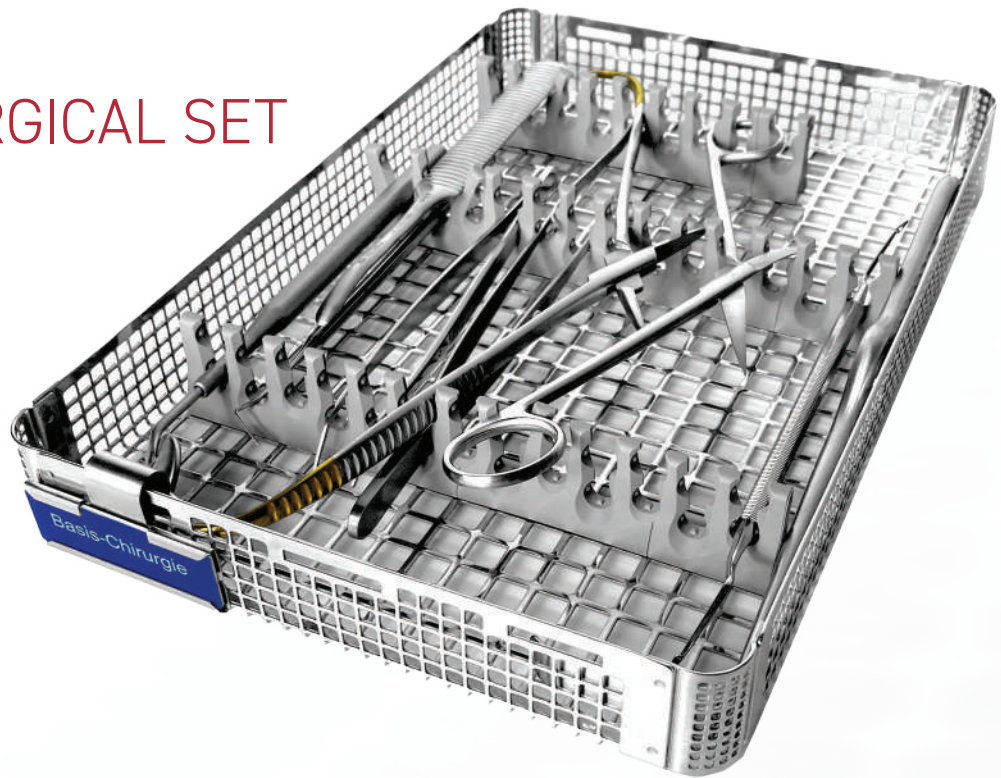

91-100-001

Basic Surgical Set

### Constituent Parts:

02-030-030	Scalpel handle, No. 3
03-441-140	JOSEPH, suture-/gum scissors, 14 cm, cvd.
08-235-160	Tissue forceps, 16cm, str., 1x2 t., v.delic.
10-801-150	COLLEGE, tweezers, 15 cm, serrated jaws
20-470-170	LICHTENBERG, needle holder, 17 cm
24-169-005	LANGENBECK, retractor, size 5, 50 x 11mm
27-717-175	Periosteal elevator, 17, 5 cm, d. e., cvd.
27-741-160	WILLIGER, periosteal elevator, 16 cm, cvd.
67-799-020	HEMINGWAY, bone curette, 18 cm, d/e., size 2
84-224-000	Mouth mirror handle, hexagonal, s.s.
86-153-001	Probe, size 1, single-ended, round handle
90-716-001	Wash Basket, Full-Size, MK 3, cross-wise racks



SET 91



02-030-030



03-441-140



08-235-160



10-801-150



20-470-170



24-169-005



27-717-175



27-741-160



67-799-020



84-224-000



86-153-001



90-716-001

# 91

SET

## APICAL SURGERY KIT

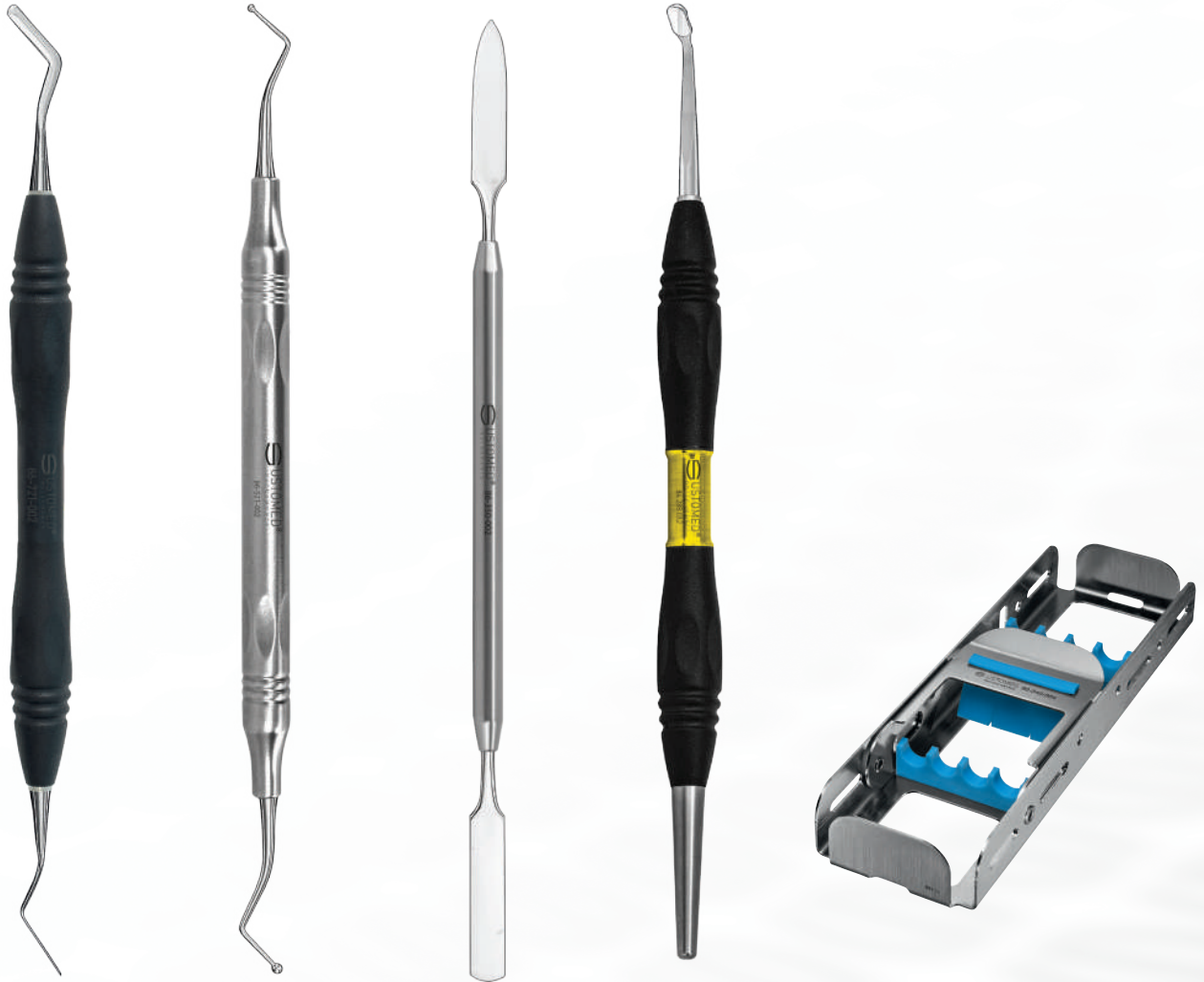

### Constituent Parts:

91-101-001

Apical Surgery Kit

86-721-002	HEIDEMANN, spatula, flex., sz.2, double-end.
86-521-002	Plugger, ball shaped, size 2, double-ended
86-350-002	Cement spatula, size 2, double-ended
84-285-062 P0T3	Root res. mirror, plane, rhodium, 6x3 mm
90-340-004	Storing Tray, Quarter-Size, for 4 instruments (Mirror, Probe, Perio Prone, Tweezers)



# 91

SET

## BASIC IMPLANTOLOGY SET

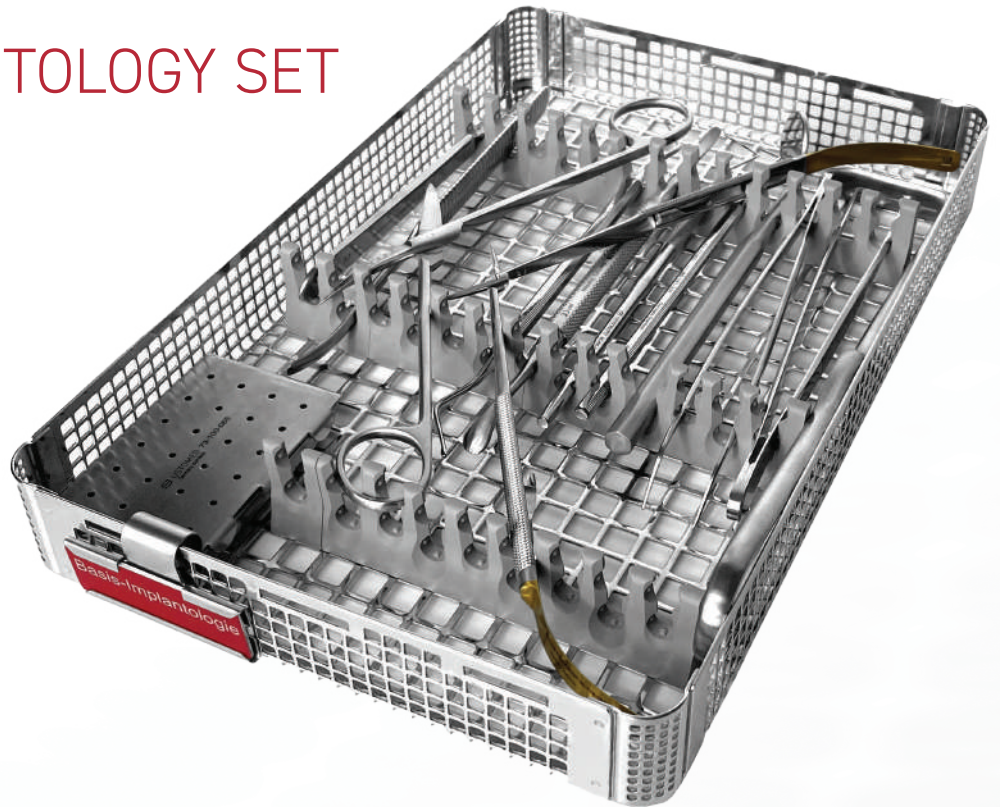

### Constituent Parts:

91-100-002

Basic Implantology Set

02-030-030	Scalpel Handle, No. 3
03-441-140	JOSEPH, suture-/gum scissors, 14 cm, cvd.
08-235-160	Tissue forceps, 16cm, str., 1x2 t., v.delic.
10-801-150	COLLEGE, tweezers, 15 cm, serrated jaws
20-710-180	BARRAQUER, TC Micro-Needle Holder, 18 cm, straight, round handle
24-169-004	LANGENBECK, retractor, size 4, 40 x 11mm
27-717-175	Periosteal elevator, 17, 5 cm, d. e., cvd.
27-741-160	WILLIGER, periosteal elevator, 16 cm, cvd.
67-799-020	HEMINGWAY, bone curette, 18 cm, d/e., size 2
73-100-065	Needle and Drill sterilizing box, perforated, 65 x 42 x 8 mm
84-224-000	Mouth mirror handle, hexagonal, s.s.
85-695-012	Periodontal probe, CP 12, colour marking
86-153-001	Probe, size 1, single-ended, round handle
90-716-001	Wash Basket, Full-Size, MK 3, cross-wise racks

SET 91



02-030-030



03-441-140



08-235-160



10-801-150



20-710-180



24-169-004



27-717-175



27-741-160



73-100-065



67-799-020



84-224-000



85-695-012



86-153-001



90-716-001

# 91

SET

## MICRO SET BASIC



91-100-003

Micro Set Basic

### Constituent Parts:

02-038-140	Micro-Scalpel Handle, 14 cm, anatomical shape
05-809-180	Micro-spring handle scrs., 18cm, cvd.round
09-270-180	DE BAKEY, micro atraum. fcps., 18cm, str.
20-710-180	BARRAQUER, TC Micro-Needle Holder, 18 cm, straight, round handle
85-691-015	UNIV.NORTH CAROLINA, period. probe CP15
85-816-170 P0T3	USTOMED, Mod. B, micro raspatory, 17cm
85-818-002 P0T3	KASAJ, tunnelling knife, Micro, 19cm, cvd.
90-716-001	Wash Basket, Full-Size, MK 3, cross-wise racks

SET 91



02-038-140



05-809-180



09-270-180



20-710-180



85-691-015



85-816-170P0T3



85-818-002P0T3

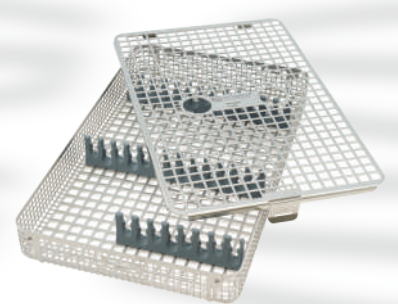

90-716-001



„I am using the I'Motion set for about a year. It is working perfectly with 6/0-7/0 threads. Thanks to it's small head and precise lock, I can work with it gently, furthermore, it is extremely rare to tear the thread, owing to it's rounded, smooth shape. It fits easily into narrow places.

## PERFECT CHOICE NOT ONLY FOR PERIODONTAL PLASTIC MICRO- SURGERIES!

Dr. Dávid Botond Hangyási



I appreciate the ergonomic and lightweight design of these instruments providing a precise and

## CONTROLLED HANDLING EVEN DURING LONG SURGERIES.

Prof. Dr. Adrian Kasaj, DDS, MSc, PhD

91-180-000

Mucogingival Plastic Surgery Set

05-803-180	I'Motion, Micro-scissors, 18cm, cvd
09-280-180	I'Motion, Micro-forceps, Cooley,
20-753-180	I'Motion, Micro-Needleholder, 18cm, curved, TC Alternativ 20-752-180 I'Motion, Micro-Needleholder, 18cm, straight, TC
02-038-140	Micro-Scalpel Handle, 14 cm, anatomical shape
10-871-160	Suture forceps, 16 cm, with eye tips
85-691-115 P0T3	UNIV.NORTH CAROLINA, period. probe CP15+Probe
85-814-175 P0T3	Papilla elevator, 17, 5cm, Mod. Z
85-818-001 P0T3	KASAJ, tunnelling knife, 20cm, straight
85-818-002 P0T3	KASAJ, tunnelling knife, Micro, 19cm, cvd.
85-818-175 P0T3	Tunneling knife, 19 cm, cvd.
90-716-001	Wash Basket, Full-Size, MK 2, Flexi-Kit



**ULTRA-LIGHT  
MICRO INSTRUMENTS**  
THE NEW BENCHMARK IN SURGERY





02-038-140



05-803-180



09-280-180



10-871-160



20-753-180  
OR  
20-752-180



85-691-115P0T3



85-814-175P0T3



85-818-001P0T3



85-818-002P0T3



85-818-175P0T3



90-716-001

# 91

## Perio-Set

91-320-006

Perio-Set, peek handle, complete

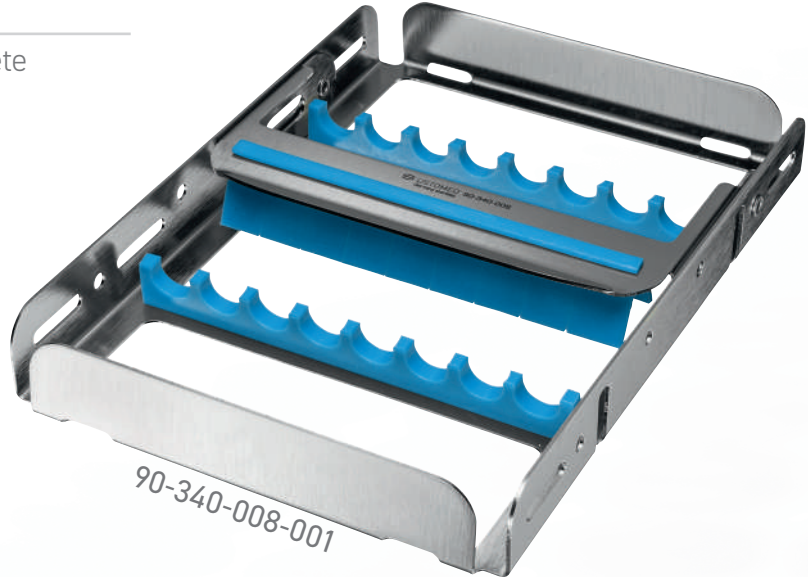

### CURETTES

GRACEY 5/6, yellow

Order Number  
85-779-056 P0T3 1/1

GRACEY 7/8, green

Order Number  
85-779-078 P0T2 1/1

GRACEY 11/12, red

Order Number  
85-779-112 P0T4 1/1

GRACEY 13/14, blue

Order Number  
85-779-134 P0T1 1/1



### SCALERS

H6/H7, black

Order Number  
85-719-067 P0T6 1/1

204 S, grey

Order Number  
85-729-204 P0T5 1/1

Complete set  
(6 instruments + 1 sterilizing frame)

Order Number  
91-320-006 1/1





## DR. MARCO DEGIDI

Adjunct Professor, Postgraduate Program in Clinic Implantology and Biomaterials, University of Chieti. Adjunct Professor, Postgraduate Master in Clinic Implantology, University of Bologna.

Speaker in many national and international seminars, congresses and courses; many national and international publications.

Active member of AO, EAO, ICOI and SIO.

Private Practice in Bologna, restricted to implant surgery & prosthetic.



## MR. GIANLUCA SIGHINOLFI

In 1989 Gianluca was awarded his diploma from the Villaggio del Fanciullo in Bologna, Italy. He immediately began work in an important dental lab in Bologna, later to become a partner.

He has had extensive specialist training and conducted courses both in Italy and internationally. Since 1996 Gianluca has collaborated with Dr. Marco Degidi and Prof. Piattelli on immediate loading research, contributing to the development of new surgery protocols and numerous articles on this subject that have been published in leading international reviews and journals.

Speaker in many national and international seminars, congresses and courses; many national and international publications.

surgery and prosthetics clinic, he knows exactly what he's talking about: perfection in practice means perfection for the patient.

## TECHNIQUE

When used at implant level, these frameworks support extremely reliable temporary restorations, and rigidly stabilize immediately loaded implants, resulting in a dramatic improvement in implant success rates.

When used at abutment level with purpose-designed DENTSPLY Implants Manufacturing GmbH components, Intra Oral Welding makes it possible to manufacture extremely high quality and durable prosthetics with enormous precision.

The key to the Intra Oral Welding technique is an ingenious welding unit that was developed by the authors in collaboration with DENTSPLY Implants Manufacturing GmbH; the unit makes it possible to create a framework from a series of welds which join abutments to a connecting titanium bar. This quick and simple procedure is completely risk free for both surgeon and patient. There is absolutely no possibility of excessive heat and the procedure causes no discomfort of any sort to the patient. The very high quality of the weld obtained using this form of electrical resistance welding is comparable and often superior to traditional methods (laser, TIG, etc).

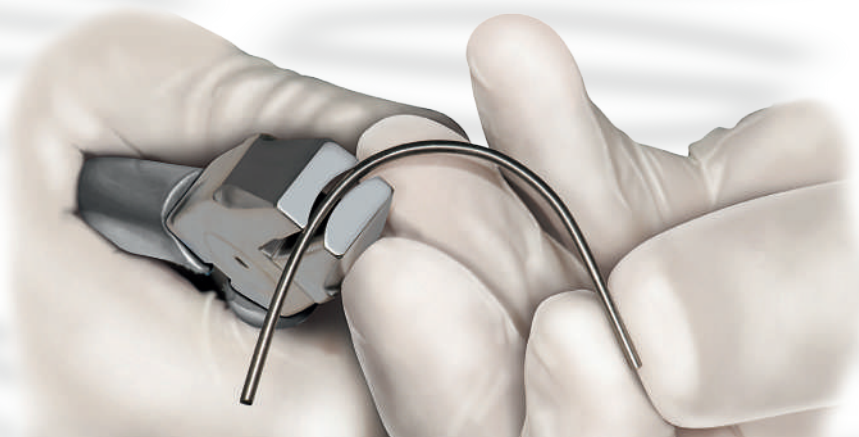

# 91

## WeldOne, IOW-Set

91-110-000

Degidi, WeldOne, IOW-Set

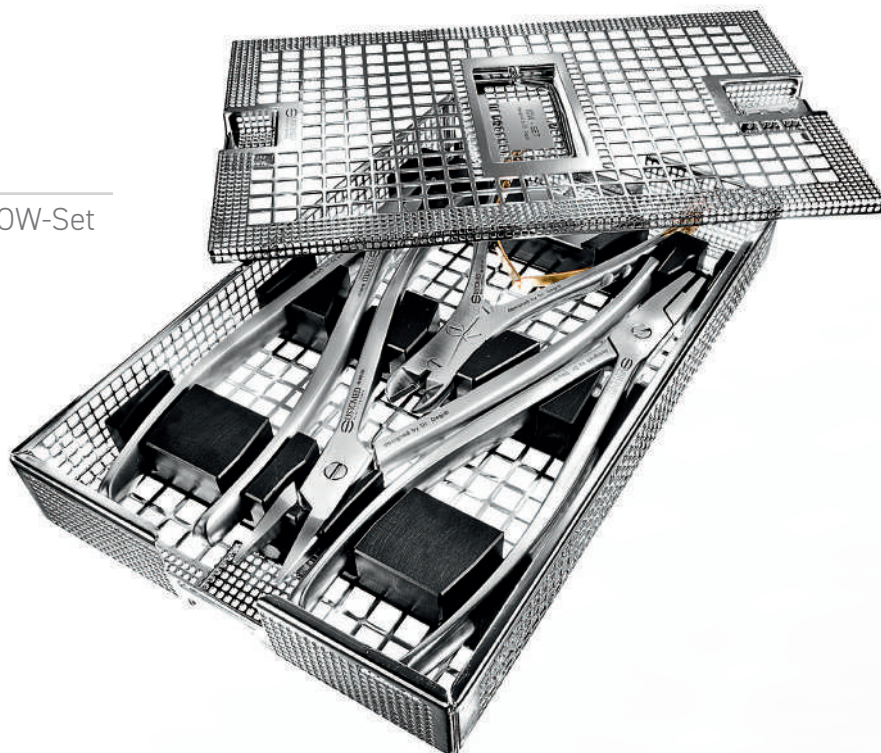

detailed information:

[www.dentsplyimplants.com](http://www.dentsplyimplants.com)

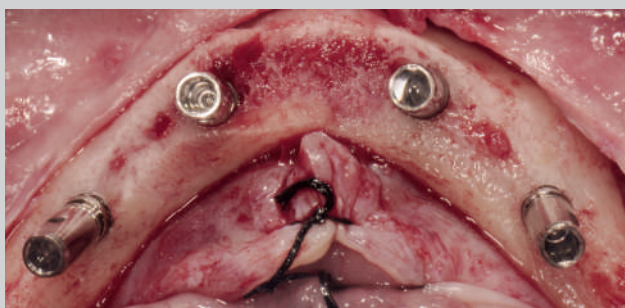

Four implants are placed in the intraforaminal region.

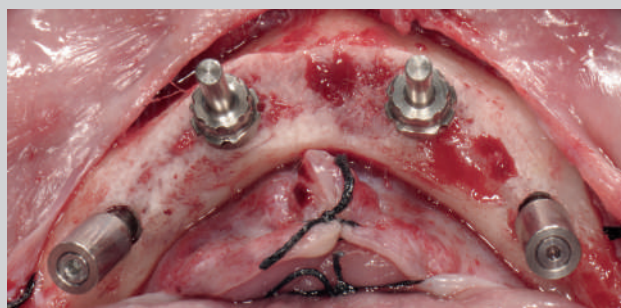

Welding abutments in position.

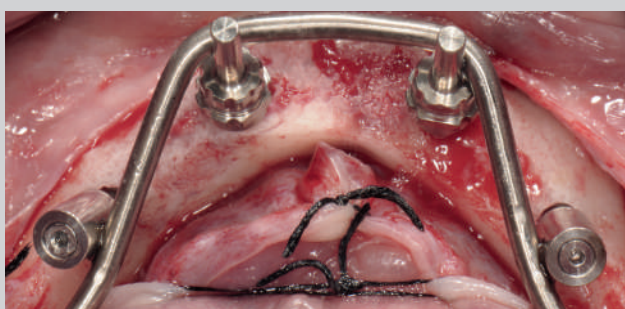

Intra-orally welded framework.



Welded framework removed and reinforced.

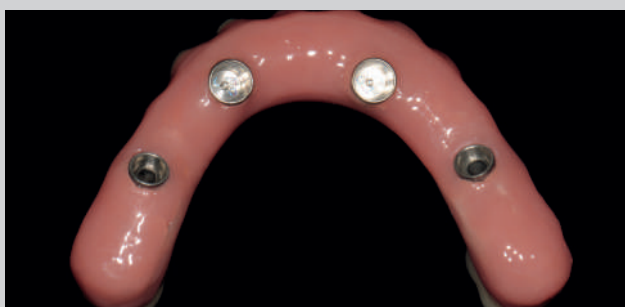

Final restoration.

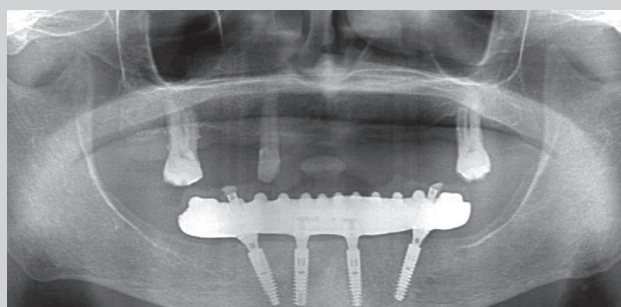

Post-op X-ray.



**Sharp Curver**  
bends the bar into more acute angles  
for single abutments.

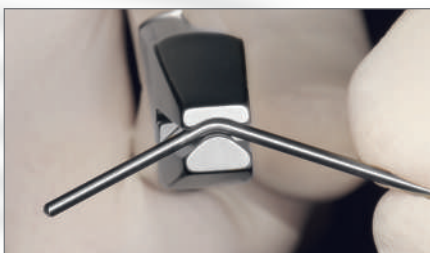

**Soft Curver**  
bends the titanium bar along the curve  
of the arch.





**Holder**  
grasps and holds the titanium bar firmly in place during the welding process.



**Cutter with tungsten carbide inserts**  
easily and efficiently cuts off excess material.







# USTOMED<sup>®</sup> INSTRUMENTE

USTOMED INSTRUMENTE      Bischof-Sproll-Straße 2  
Ulrich Storz GmbH & Co. KG      78532 Tuttlingen / Germany

Manufacturer for Surgical and      Phone: +49 (0) 74 61 / 9 65 85 0  
Dental Instruments      Fax: +49 (0) 74 61 / 9 65 85 65